

LMT Mercer Group, Inc.

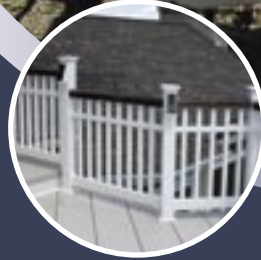

2008
CATALOG

INNOVATIVE PRODUCTS FOR THE VINYL
FENCE, DECK & RAILING INDUSTRY

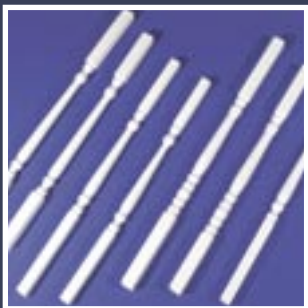

LMT Mercer Group, Inc. LMT Mercer Group, Inc was formed in 1987 and supplies the vinyl and wood composite fence and deck industry with high quality component parts. Today, LMT is the largest manufacturer of vinyl fence, deck and railing accessories in the US and Canada, offering more than 950 products from which to choose. We manufacture a broad range of products designed to meet the needs of a diverse and demanding customer base, introducing at least 20 new products each year.

Headquartered in Lawrenceville NJ, we operate manufacturing plants in New Jersey and Ohio, with distribution centers in New Jersey, Ohio and Utah.

LMT uses automatic high-cavitation tooling to sustain its competitive edge. LMT operates 33 state-of-the-art injection molding machines equipped with servo-robotics and nitrogen gas-assist capabilities. Machine sizes range from 60 to 1,000 tons.

Dedicated Customer Service and Sales teams ensure that customers receive individual attention and care throughout the order process.

What sets LMT Mercer Group, Inc. apart from the competition?

- LMT manufactures products in the USA (except for solar lights).
- We offer a lifetime warranty on every product manufactured in the USA.
- We use only prime grade, certifiable virgin vinyl resin, which means you can depend on the strength and durability of the product.
- Custom blended wood composite products available to meet custom applications.
- We do not mix our vinyl with other inferior products.
- We use UV inhibitors to stop yellowing and fading.
- Our in-house tooling capabilities and engineering services are available to assist you with your individual needs.
- We offer AC174 compliant handrail accessories.
- Thick, professional grade vinyl means that our garden products will never warp, dent, shrink, chip or crack.
- Our outstanding Customer Service team follows up on every order.
- Our experienced Sales Team ensures that all of your needs are met.

OUR MISSION

The Mission of LMT Mercer Group, Inc. is to be the industry leader in the manufacturing of vinyl caps, accessories and kit products. We will accomplish this by setting the benchmark for quality, customer service and competitive pricing.

LMT Mercer Group, Inc. will also set the pace for new innovations by employing the industry's best. We will be creative not only with the development of new products, but with manufacturing, distribution and sales. We will use all resources available to us in order to make our customers the most competitive they can be, since we are not only their vendor but also their partner.

Anthony Lesenskyj
President

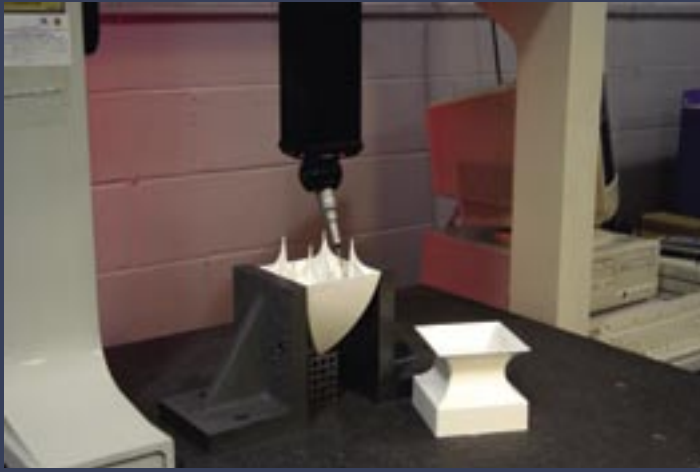

Customer-Focused Partnership

New product molds are designed and developed based primarily on ideas from our customers. As a company, LMT prides itself in listening to customer feedback and implementing their innovations.

Custom Mold-Making Capabilities

LMT's sister company, Lawrence Mold and Tool Corporation, was originally established in 1972 as a custom mold-making facility by Ukrainian-born George Lesenskyj Sr. located in Trenton, NJ, the company quickly grew with a philosophy of honesty, hard work and dedication.

Specializing in building multi-cavity plastic injection tooling, Lawrence Mold and Tool Corp. builds close to 100 new molds per year for a variety of industries. They have created molds for everything from hard hats to baby bottles.

As one of their largest customers, LMT Mercer Group, Inc. has the competitive advantage of an innovative, flexible and customer-focused partnership.

Leaders in Innovation

LMT Mercer Group, Inc. prides itself in setting the pace for new innovations and products. Lawrence Mold and Tool Corp. has the ability to support this pace by building tools that ensure LMT is always on the leading edge of the industry.

Lawrence Mold and Tool Corp. builds a diverse assortment of molds, from small, single-cavity prototypes to 64-cavity, high-production molds. Their experience allows them to create molds for a variety of materials used by our customers, such as PVC, Polyethylene and Polycarbonate.

The relationship between these companies allows LMT the ability to create any mold requested. It also ensures that customers receive quality product at competitive prices.

This relationship allows LMT to keep up with code changes. We are able to make or modify existing parts quickly. We also have the ability to make proprietary parts for our customers, offering a way for them to distinguish their product offerings from the competition.

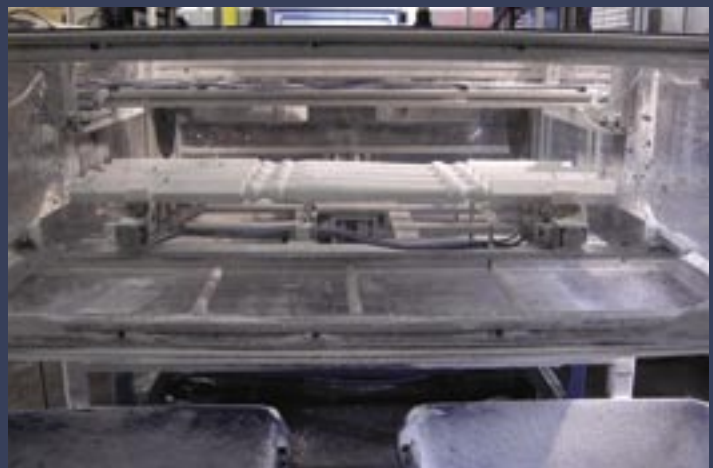
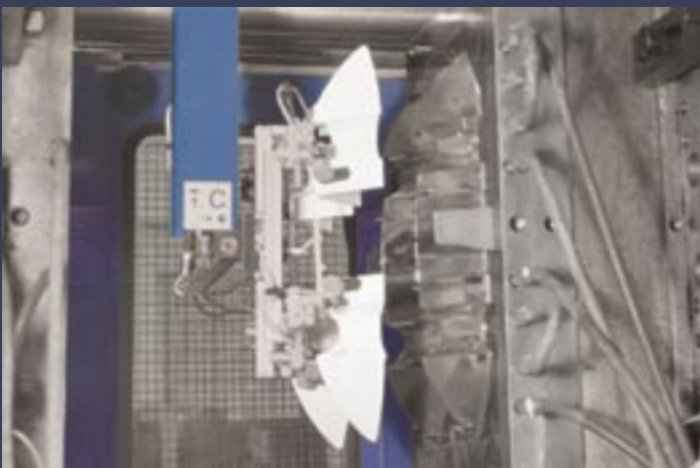

LMT Mercer Group, Inc. 690 Puritan Avenue, Lawrenceville, NJ 08648, www.lmtproducts.com
TO ORDER: Call 888-570-5252 ext. 74, Fax: 609-989-1199, Email: orders@lmtproducts.com



GENERAL INFORMATION



Trenton, New Jersey
Headquarters
Manufacturing
Distribution

Hartville, Ohio
Manufacturing
Distribution

Salt Lake City, Utah
Distribution

Color Policy

LMT Mercer Group, Inc. stocks standard White, LMT Almond, LMT Khaki and LMT Beige. We offer most of our accessories in these four colors that match various manufacturer's extrusions, which are commonly known by the color names of "Khaki, Tan, Adobe and Beige."

These products are in stock and offered in minimal box quantities for immediate shipment. There is a 10% up charge on LMT Almond, and a 15% up charge on LMT Khaki and LMT Beige for all products except Thermo-Formed Spindles. Thermo-Formed Spindles are a 25% up charge for LMT Almond, LMT Khaki and LMT Beige.

Other colors are special runs and most require a 2000 part minimum production run. There is a 20% up charge on custom color runs, unless otherwise noted. The lead times on special runs vary throughout the year as they are dependent on the seasonality.

For more information on colors or to order sample chips, please call Customer Service at 888-570-5252 ext. 74.

Branding

Branding your company name or logo is available on our most popular caps. There is a minimum order of 2,500 pieces. The lead time is the same as the color policy. Additional charge of 10¢ for one side of a cap or 15¢ for two sides. There is no die charge.

Ordering Policy

Products are sold in full box quantities only.

Returned Goods Policy

If a customer orders incorrect products:

- Returns will only be accepted within 30 days from order delivery.
- Returns will not be accepted without a valid RMA number.
- Each package on a return needs a return authorization number clearly indicated.
- All materials are to be returned freight prepaid. Collect shipments will be refused.
- No returns will be accepted for custom ordered materials (specials) or for custom color items.
- No returns will be accepted on partial box quantities.
- A restock fee of 15% will be charged for all accepted returns.
- Credit will be issued only for those items listed on the Return Authorization that actually arrives in "like new" condition at LMT.

If a customer needs to return damaged or defective products:

- Products damaged during shipment will only be accepted within 30 days from order delivery.
- Contact Customer Service immediately upon discovery of damaged or defective products for return/replacement instructions.



Mercer Group, Inc.

690 Puritan Avenue
Lawrenceville, NJ 08648

P: 1.888.570.5252
F: 1.609.989.1199

E: orders@lmtproducts.com
W: www.lmtproducts.com

LMT DEALER DISPLAYS

Description

Product
No.

Value

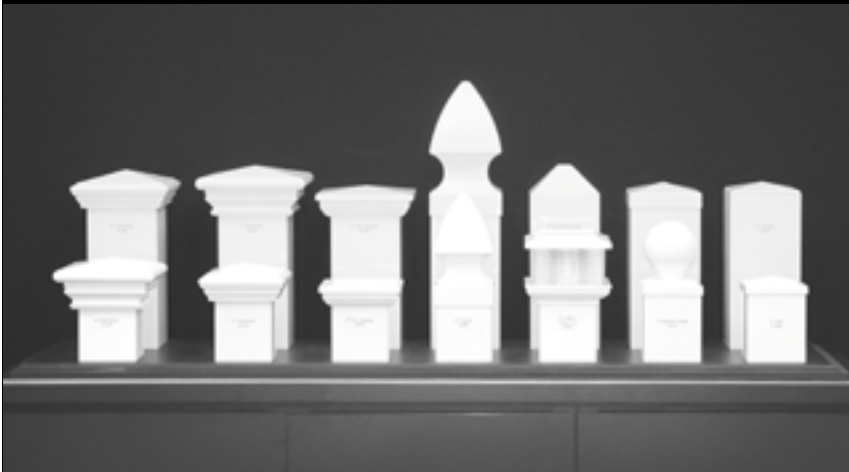

Cap Display

N/A

200.00



Decorative Accent
Display
Picket Fence Scrolls

#5760

150.00











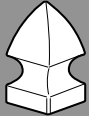
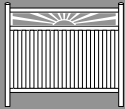

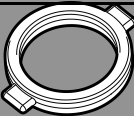
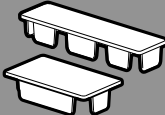

Spaghetti Rail Display

#5759

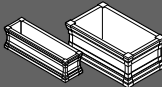
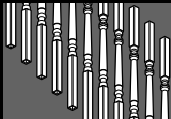
350.00

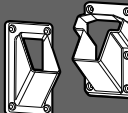
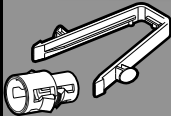
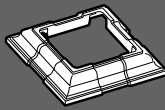
TABLE OF CONTENTS

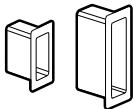
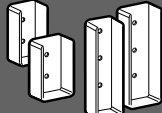
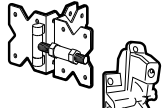
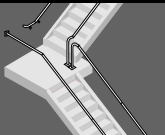
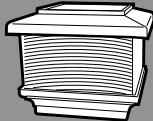
| | | | | | | | |
|---|---|--|---|--|---|---|--------------------|
| Post, Picket & Rail Caps |  | Post Caps | 9 | Sunburst Panels | 59 |  | Decorative Accents |
| |  | Lighted Post Caps <i>Lighted Solar Post Caps</i> | 14 | Rose Scrolls | 60 |  | |
| |  | Picket Caps | 15 | Picket Scrolls | 61 |  | |
| |  | Picket Cap Adapters | 22 | Decorative Inserts | 62 |  | |
| |  | Rail Caps | 23 | Garden Jewelry | 65 |  | |
| | | | <i>Arbors, Pergolas, Flower Boxes and Planters, Accent Lighting, Arches, Pergola End Caps</i> | |  | | |
| Deck & Rail Components |  | Spindles, Porch Posts & Accessories | 25 | Adhesive | 75 |  | Fasteners & Screws |
| |  | Brackets | 35 | Fasteners | 76 |  | |
| |  | Post Skirts | 46 | Screws | 79 |  | |
| |  | Post Accents | 47 | Gate Sockets | 81 |  | Gate Accessories |
| |  | Rail Mounts | 49 | Gate Hardware | 82 |  | |
| |  | Spaghetti Rail | 51 | Additional Information | 87 | | Additional Info |
| |  | Lighting | 55 | <i>Warranties</i> | | | |
| <p>Visit www.lmtproducts.com to print a copy of the 2008 catalog.</p> | | | | <ul style="list-style-type: none"> • <i>Product Information</i> • <i>Order Form</i> • <i>Credit Application</i> • <i>Consent Form</i> • <i>Company Information Form</i> | | | |

TO ORDER: Call 888-570-5252 ext. 74, Fax: 609-989-1199, Email: orders@lmtproducts.com

NEW PRODUCTS

LMT Mercer Group, Inc. prides itself in setting the pace for new innovations and products. Throughout the year, we introduce new products that support our customers' ability to provide all accessories needed to build premium fences, decks and railings.

- Use this tab to insert new product information and product flyers sent to you during the year.



NEW PRODUCTS











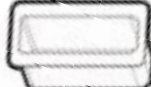

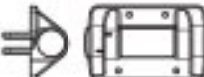

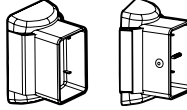

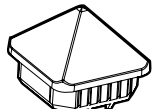
LMT Mercer Group, Inc. prides itself in setting the pace for new innovations and products. Throughout the year, we introduce new products that support our customers' ability to provide all accessories needed to build premium fences, decks and railings.

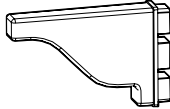
- Use this tab to insert new product information and product flyers sent to you during the year.



SO MANY CHOICES....

INTRODUCING 35 + NEW PRODUCTS FOR 2008

| | | | | | |
|--------------------|---|---|--------------------|---|--|
| NEW RELEASE |  | Bracket Kits Page: 37 | NEW RELEASE |  | Gate Sockets Page: 82 |
| NEW RELEASE |  | Polycarbonate Bracket Kits Page: 39 | NEW RELEASE |  | Nylon Gate Hardware Page: 82 |
| NEW RELEASE |  | Galaxy Post Cap Adapter Page: 56 | NEW RELEASE |  | Multi Angle Handrail Brackets Page: 43 |
| NEW RELEASE |  | Galaxy Solar Post Cap Page: 55 | NEW RELEASE |  | Weldable Picket Caps Page: 20 |
| NEW RELEASE |  | Galaxy Solar Wedge Page: 55 | NEW DESIGN |  | Pergola End Caps Page: 71 |
| NEW RELEASE |  | Pineapple Post Cap Page: 13 | | | |
| NEW RELEASE |  | Large Ball Cap Page: 13 | | | |
| NEW RELEASE |  | Urn Cap Page: 13 | | | |
| NEW RELEASE |  | Covered Bracket Kit Page: 35 | | | |
| NEW RELEASE |  | Covered Bracket Kit Adapters Page: 35 | | | |
| NEW RELEASE |  | Galaxy Ornamental Solar Post Cap Page: 57 | | | |
| NEW RELEASE |  | Galaxy Ornamental Solar Wedge Page: 57 | | | |
| NEW RELEASE |  | Post Surface Mounts Page: 31 | | | |

TO ORDER: Call 888-570-5252 ext. 74, Fax: 609-989-1199, Email: orders@lmtproducts.com

POST, PICKET & RAIL CAPS

LMT's Cap assortment is the largest in the industry. We offer more than 90 Post, Picket and Rail Caps, all available in four color options. Our Caps are offered in a variety of sizes to fit most vinyl profiles available in the industry. We also offer innovative products such as Self-Locking Picket Caps and Picket Cap Adapters to make installation easier than ever.



Post, Picket & Rail Caps

Post Caps

Lighted Post Caps

Picket Caps

Picket Cap Adapters

Rail Caps



 LMT Mercer Group, Inc.

POST, PICKET & RAIL CAPS

LMT's Cap assortment is the largest in the industry. We offer more than 90 Post, Picket and Rail Caps, all available in four color options. Our Caps are offered in a variety of sizes to fit most vinyl profiles available in the industry. We also offer innovative products such as Self-Locking Picket Caps and Picket Cap Adapters to make installation easier than ever.

Post, Picket & Rail Caps



Post Caps

Lighted Post Caps

Picket Caps

Picket Cap Adapters

Rail Caps



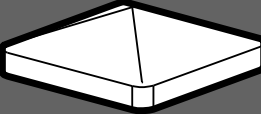
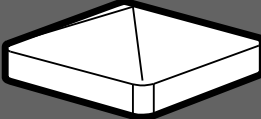
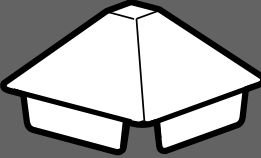
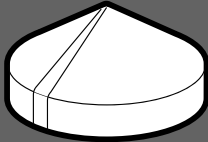

POST CAPS

| | Product No. | Description | Box Wt. | Box Qty. |
|---|--------------|---|---------|----------|
|  | #1000 | 3-1/2" Flat <i>Maximum profile dimensions: 3.510" x 3.510" / Corner radius: Square / Fits externally / Extends 0.450" over the profile / Total height: 1.250".</i> | 24 lbs | 180 |
| | #1003 | 4" Flat <i>Maximum profile dimensions: 4.025" x 4.025" / Corner radius: Square / Fits externally / Extends 0.450" over the profile / Total height: 1.250".</i> | 18 lbs | 120 |
| | #1006 | 5" Flat <i>Maximum profile dimensions: 4.990" x 4.990" / Corner radius: Square / Fits externally / Extends 0.460" over the profile / Total height: 1.250".</i> | 15 lbs | 70 |
| | #1106 | 5-1/2" Flat <i>Maximum profile dimensions: 5.495" x 5.495" / Corner radius: Square / Fits externally / Extends 0.280" over the profile / Total height: 0.750".</i> | 9 lbs | 40 |
| | #1009 | 5-1/2" Flat <i>Maximum profile dimensions: 5.595" x 5.595" / Corner radius: Square / Fits externally / Extends 0.500" over the profile / Total height: 1.250".</i> | 14 lbs | 50 |
|  | #1204 | 3-1/2" Horse (Long Lipped) <i>Maximum profile dimensions: 3.510" x 3.510" / Corner radius: 0.125" / Fits externally / Extends 0.950" over the profile / Total height: 1.424".</i> | 17 lbs | 125 |
| | #1071 | 4" Horse (Long Lipped) <i>Maximum profile dimensions: 4.020" x 4.020" / Corner radius: 0.188" / Fits externally / Extends 0.950" over the profile / Total height: 1.750".</i> | 21 lbs | 125 |
| | #1011 | 5" Horse (Long Lipped) <i>Maximum profile dimensions: 5.020" x 5.020" / Corner radius: 0.188" / Fits externally / Extends 1.000" over the profile / Total height: 1.750".</i> | 37 lbs | 160 |
| | #1247 | 6" Horse (Long Lipped) <i>Maximum profile dimensions: 6.020" x 6.020" / Corner radius: 0.125" / Fits externally / Extends 0.920" over the profile / Total height: 1.900".</i> | 50 lbs | 162 |
| | #1171 | 6-1/2" Horse (Long Lipped) <i>Maximum profile dimensions: 6.515" x 6.515" / Corner radius: Square / Fits externally / Extends 1.000" over the profile / Total height: 1.979".</i> | 12 lbs | 30 |
|  | #1020 | 5" Internal Pyramid <i>Minimum profile inside dimensions: 4.660" x 4.660" / Corner radius: 0.375" / Fits internally / Extends 1.000" into the profile / Total height: 3.000".</i> | 35 lbs | 130 |
|  | #1203 | 3" Round Cap <i>Maximum profile diameter dimension: 3.015" / Fits externally / Total height: 1.576" / Branding not available on this item.</i> | 11 lbs | 150 |

Colors and Branding are available. See page 3.

TO ORDER: Call 888-570-5252 ext. 74, Fax: 609-989-1199, Email: orders@lmtproducts.com

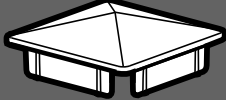
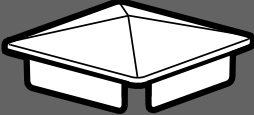
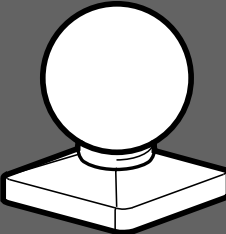
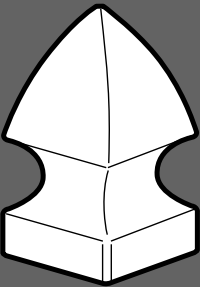
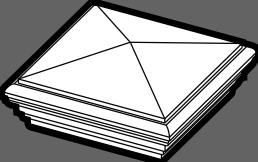
POST CAPS

| | Product No. | Description | Box Wt. | Box Qty. |
|--|-------------|--|---------|----------|
|  | #1078 | 4" Internal <i>Minimum profile inside dimensions: 3.675" X 3.675" / Wall: 0.165" / Corner radius: 0.250" Fits internally / Extends 0.750" into the profile / Total height: 1.500".</i> | 15 lbs | 108 |
| | #1080 | 4" RS Internal <i>Minimum profile inside dimensions: 3.715" X 3.715" / Wall: 0.150" / Corner radius: 0.250" Fits internally / Extends 0.750" into the profile / Total height: 1.500".</i> | 15 lbs | 108 |
|  | #1079 | 5" Internal <i>Minimum profile inside dimensions: 4.700" X 4.700" / Wall: 0.150" / Corner radius: 0.375" Fits internally / Extends 0.760" into the profile / Total height: 1.750".</i> | 46 lbs | 200 |
|  | #1117 | 4" Seamless Dome <i>Maximum profile dimensions: 4.025" X 4.025" / Corner radius: Square / Fits externally / Extends .680" over the profile / Total height: 5.000" / Dome diameter: 3.818".</i> | 22 lbs | 60 |
| | #1119 | 5" Seamless Dome <i>Maximum profile dimensions: 5.025" X 5.025" / Corner radius: Square / Fits externally / Extends .680" over the profile / Total height: 6.160" / Dome diameter: 4.695".</i> | 19 lbs | 32 |
| Seamless!  | #1002 | 3-1/2" Seamless Gothic <i>Maximum profile dimensions: 3.510" X 3.510" / Corner radius: Square / Fits externally / Extends 0.450" over the profile / Total height: 4.875".</i> | 36 lbs | 60 |
| | #1005 | 4" Seamless Gothic <i>Maximum profile dimensions: 4.010" X 4.010" / Corner radius: 0.188" / Fits externally / Extends 1.350" over the profile / Total height: 7.750".</i> | 26 lbs | 45 |
| | #1008-24 | 5" Seamless Gothic <i>Maximum profile dimensions: 5.010" X 5.010" / Corner radius: .125" / Fits externally / Extends 1.600" over the profile / Total height: 9.625".</i> | 23 lbs | 24 |
| | #1008-45 | 5" Seamless Gothic <i>Maximum profile dimensions: 5.010" X 5.010" / Corner radius: .125" / Fits externally / Extends 1.600" over the profile / Total height: 9.625".</i> | 46 lbs | 45 |
|   | #1233 | 4" Nantucket <i>Maximum profile dimensions: 4.020" X 4.020" / Corner radius: .188" / Fits externally / Extends 1.000" over the profile / Total height: 2.530".</i> See our matching Post Skirts (#1232) on page 47. | 14 lbs | 24 |
| | #1236 | 5" Nantucket <i>Maximum profile dimensions: 5.010" X 5.010" / Corner radius: .188" / Fits externally / Extends 1.000" over the profile / Total height: 2.530".</i> See our matching Post Skirts (#1235) on page 47. | 30 lbs | 54 |

TO ORDER: Call 888-570-5252 ext. 74, Fax: 609-989-1199, Email: orders@lmtproducts.com

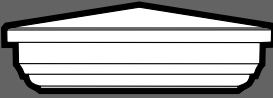
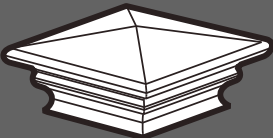
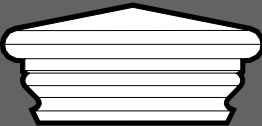
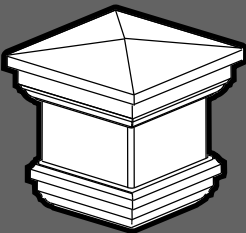

POST CAPS

| | Product No. | Description | Box Wt. | Box Qty. |
|--|-------------|--|---------|----------|
|   | #1039 | 4" New England <i>Maximum profile dimensions: 4.010" X 4.010" / Corner radius: .125" / Fits externally / Extends 1.600" over the profile / Total height: 2.250".</i> See our matching Post Skirts (#1069) on page 46. | 17 lbs | 32 |
| | #1040 | 5" New England <i>Maximum profile dimensions: 5.010" X 5.010" / Corner radius: .125" / Fits externally / Extends 1.600" over the profile / Total height: 2.250".</i> See our matching Post Skirts (#1070) on page 46. | 48 lbs | 60 |
| | #1302 | 6" New England <i>Maximum profile dimensions: 6.010" X 6.010" / Corner radius: .180" / Fits externally / Extends .920" over the profile / Total height: 1.906".</i> See our matching Post Skirts (#1301) on page 46. | 23 lbs | 32 |
| | #1304 | 6-1/2" New England <i>Maximum profile dimensions: 6.510" X 6.510" / Corner radius: .180" / Fits externally / Extends .920" over the profile / Total height: 1.906".</i> See our matching Post Skirts (#1303) on page 46. | 22 lbs | 32 |
|   | #1139 | 4" Federation <i>Maximum profile dimensions: 4.010" X 4.010" / Corner radius: .125" / Fits externally / Extends 1.500" over the profile / Total height: 3.363".</i> See our matching Post Skirts (#1137) on page 47. | 39 lbs | 40 |
| | #1140 | 5" Federation <i>Maximum profile dimensions: 5.010" X 5.010" / Corner radius: .125" / Fits externally / Extends 1.500" over the profile / Total height: 3.463".</i> See our matching Post Skirts (#1138) on page 47. | 52 lbs | 40 |
| | #1225 | 6" Federation <i>Maximum profile dimensions: 6.020" X 6.020" / Corner radius: .135" / Fits externally / Extends 1.500" over the profile / Total height: 3.613" / Over all outside dimension: 9.312".</i> See our matching Post Skirts (#1224) on page 47. | 24 lbs | 24 |
| | #1213 | 6-1/2" Federation <i>Maximum profile dimensions: 6.520" X 6.520" / Corner radius: .135" / Fits externally / Extends 1.500" over the profile / Total height: 3.613" / Over-all outside dimension: 9.312".</i> See our matching Post Skirts (#1212) on page 47. | 33 lbs | 24 |
|  | #1095 | 4" Newport Post Cap <i>Maximum profile dimensions: 4.010" x 4.010" / Corner radius: Square / Fits externally / Extends 1.250" over the profile / Total height 6.125".</i> Available in White. | 25 lbs | 12 |

TO ORDER: Call 888-570-5252 ext. 74, Fax: 609-989-1199, Email: orders@lmtproducts.com



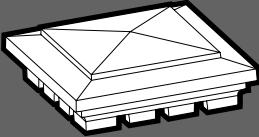

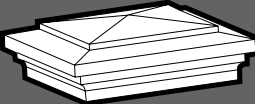
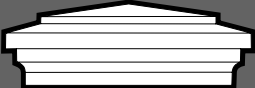
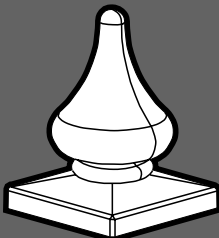
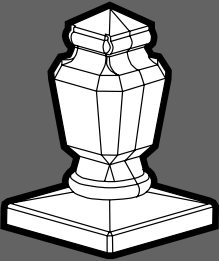
POST CAPS

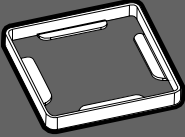
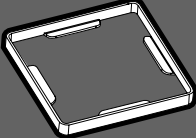

| | Product No. | Description | Box Wt. | Box Qty. |
|---|-------------|--|---------|----------|
|   | #1325 | 4" Bridgeport <i>Maximum profile dimensions: 4.010" x 4.010" / Corner radius: .060" / Fits externally / Extends 1.44" over the profile / Total height: 2.24".</i> | 12 lbs | 24 |
| | #1328 | 5" Bridgeport <i>Maximum profile dimensions: 5.010" x 5.010" / Corner radius: .060" / Fits externally / Extends 1.44" over the profile / Total height: 2.32".</i> | 12 lbs | 20 |
| | #1331 | 6" Bridgeport <i>Maximum profile dimensions: 6.010" x 6.010" / Corner radius: .060" / Fits externally / Extends 1.49" over the profile / Total height: 2.44".</i> | 18 lbs | 24 |
| | #1334 | 6-1/2" Bridgeport <i>Maximum profile dimensions: 6.510" x 6.510" / Corner radius: .060" / Fits externally / Extends 1.49" over the profile / Total height: 2.47".</i> | 20 lbs | 24 |
|   | #1326 | 4" Hampton <i>Maximum profile dimensions: 4.010" x 4.010" / Corner radius: .060" / Fits externally / Extends 1.44" over the profile / Total height: 2.24".</i> | 12 lbs | 24 |
| | #1329 | 5" Hampton <i>Maximum profile dimensions: 5.010" x 5.010" / Corner radius: .060" / Fits externally / Extends 1.44" over the profile / Total height: 2.32".</i> | 12 lbs | 20 |
| | #1332 | 6" Hampton <i>Maximum profile dimensions: 6.010" x 6.010" / Corner radius: .060" / Fits externally / Extends 1.49" over the profile / Total height: 2.44".</i> | 18 lbs | 24 |
| | #1335 | 6-1/2" Hampton <i>Maximum profile dimensions: 6.510" x 6.510" / Corner radius: .060" / Fits externally / Extends 1.49" over the profile / Total height: 2.47".</i> | 20 lbs | 24 |
|  | #1348 | 4" Teardrop <i>Maximum profile dimensions: 4.000" x 4.000" / Corner radius: sharp / Fits externally / Extends .660" over the profile / Total height: 7.375". Available in White and LMT Almond.</i> | 29 lbs | 48 |
| | #1349 | 5" Teardrop <i>Maximum profile dimensions: 5.000" x 5.000" / Corner radius: sharp / Fits externally / Extends .660" over the profile / Total height: 7.375". Available in White and LMT Almond.</i> | 31 lbs | 48 |
|  | #1350 | 4" Coachman <i>Maximum profile dimensions: 4.000" x 4.000" / Corner radius: sharp / Fits externally / Extends .660" over the profile / Total height: 7.187". Available in White and LMT Almond.</i> | 33 lbs | 48 |
| | #1351 | 5" Coachman <i>Maximum profile dimensions: 5.000" x 5.000" / Corner radius: sharp / Fits externally / Extends .660" over the profile / Total height: 7.375". Available in White and LMT Almond.</i> | 36 lbs | 48 |

TO ORDER: Call 888-570-5252 ext. 74, Fax: 609-989-1199, Email: orders@lmtproducts.com

POST CAPS

| | Product No. | Description | Box Wt. | Box Qty. |
|---|-----------------------------|--|---------|----------|
|  | #1317A | 4" Modular Adapter <i>Fits internally on LMT's 4" cap.</i> | 2.5 lbs | 50 |
|  | #1317B | 5" Modular Adapter <i>Fits internally on LMT's 5" cap.</i> | 2.3 lbs | 48 |
|  | #1389 NEW RELEASE | 5" Pineapple Cap <i>Maximum profile dimension 5.010"x 5.010" / Corner radius .125" / Extends .625" over profile / Can be used on any size of post cap over 5" with use of Modular Adapter #1317B / White Only / Cap Size 11.125" x 5.25".</i> | 4 lbs | 4 |
|  | #1390 NEW RELEASE | 5" Large Ball Cap <i>Maximum profile dimension 5.010"x 5.010" / Corner radius .125" / Extends .625" over profile / Can be used on any size of post cap over 5" with use of Modular Adapter #1317B / White Only / Cap Size 8.75" x 5.835".</i> | 3 lbs | 4 |
|  | #1391 NEW RELEASE | 5" Urn Cap <i>Maximum profile dimension 5.010"x 5.010" / Corner radius .125" / Extends .625" over profile / Can be used on any size of post cap over 5" with use of Modular Adapter #1317B / White Only / Cap Size 10.25" x 5.25".</i> | 4 lbs | 4 |

The Modular Adapters are designed to aid in attaching two post caps together, creating numerous new options for customers. Simply adhere a Modular Adapter to the corresponding 4" or 5" LMT Post Cap of your choice. Then adhere this cap to a 5", 6" or 6.5" Post Cap for a unique, appealing new post cap. See some popular combinations below.







- | | | | | | |
|--------------------------------|--------------------------------|--------------------------------|--------------------------------|--------------------------------|-----------------------------------|
| 4" Gothic Cap (#1005) | 4" Dome Cap (#1117) | 4" Gothic Cap (#1005) | 5" Dome Cap (#1119) | 5" Dome Cap (#1119) | 5" Gothic Cap (#1008-24) |
| 4" Modular Adapter (#1317A) | 4" Modular Adapter (#1317A) | 4" Modular Adapter (#1317A) | 5" Modular Adapter (#1317B) | 5" Modular Adapter (#1317B) | 5" Modular Adapter (#1317B) |
| 4" Federation Cap (#1139) | 4" New England Cap (#1039) | 5" Nantucket Cap (#1236) | 5" New England Cap (#1040) | 6" Federation Cap (#1225) | 6-1/2" New England Cap (#1304) |

TO ORDER: Call 888-570-5252 ext. 74, Fax: 609-989-1199, Email: orders@lmtproducts.com

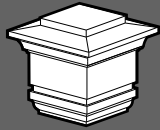
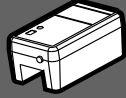
LIGHTED POST CAPS

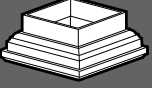

| | Product No. | Description | Box Wt. | Box Qty. |
|---|-------------|--|----------|-----------|
|  | #5553 | Low Voltage Lighted Post Cap <i>Fits externally over 4" x 4" posts and also fits 3-1/2" x 3-1/2" with adjustable inside tab. May be installed internally onto 5" x 5" posts (Method A) or externally using Part Number #5560 (Method B). Available in White and LMT Almond.</i> | 2 lbs | 6 |
|  | #5551 | 60 Watt Transformer <i>Programmable / Includes photocell / Supports 15 4-watt lights.</i> | 3 lbs | 1 |
| | #5552 | 88 Watt Transformer <i>Programmable / Includes photocell / Supports 22 4-watt lights.</i> | 4 lbs | 1 |
|  | #5550 | Low Voltage Lighted Post Cap Kit <i>Includes 6 Lighted Post Caps, 6 low voltage light sockets & cams, 12 #4 S/S mounting screws, 6 (4 watt) light bulbs, 1 (60 watt) programmable transformer w/photocell 75 Ft, 14 gauge cable and 1 cable extension connector.</i> | 16 lbs | 1 |
|  | #5560 | 5" Lighted Post Cap Adaptor <i>Fits externally over a 5" x 5" Post. (See Method #B below.) Available in White.</i> | 5 lbs | 12 |
| | | | Roll Wt. | Roll Qty. |
|  | #5554 | 14 Gauge Wire | 27 lbs | 500 ft |
| | #5555 | 12 Gauge Wire | 30 lbs | 500 ft |

Attaching to a 5" Post



Method A - Internal.
Fit with screws



Method B - External.
Using #5560 Adaptor



LIGHTED SOLAR POST CAPS



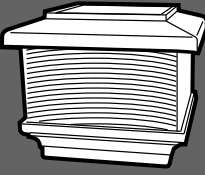

| | Product No. | Description | Box Wt. | Box Qty. |
|---|-------------|--|---------|----------|
|  | #5558 | Galaxy Solar Post Cap <i>Fits externally over 4" x 4" or 5" x 5" posts / 4" x 4" solar panel / Dual Ni-Cad rechargeable batteries / Four LED lights / Up to 12 hours of light / Includes adapter for use with 4" posts / Available in White and LMT Almond.</i> | 47 lbs | 24 |
| | | See lighting section for additional post lights, colors, post size applications, and finishes. | | |

TO ORDER: Call 888-570-5252 ext. 74, (after 5:30 PM EST ext. 36) Fax: 609-989-1199, Email: orders@lmtproducts.com

PICKET CAPS



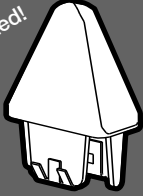
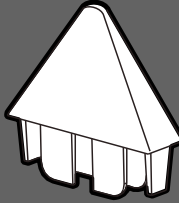
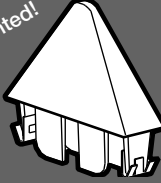

| | Product No. | Description | Box Wt. | Box Qty. |
|--|-------------|--|---------|----------|
|  | #1082 | <p>3/4" x 1-1/2" Sharp</p> <p><i>Minimum profile inside dimensions: 0.574" X 1.330" / Corner radius: 0.143" / Fits internally / Extends 0.745" into the profile / Total height: 2.330".</i></p> <p>3/4" x 1-1/2" Sharp</p> | 11 lbs | 400 |
| Patented!  | #1057 | <p>3/4" x 1-1/2" Self-Locking Sharp</p> <p><i>Minimum profile inside dimensions: 0.574" X 1.330" / Wall: 0.080" / Corner radius: 0.143" / Fits internally / Extends 0.745" into the profile / Total height: 2.330".</i></p> <p>U.S. Patent #6,561,499</p> | 13 lbs | 400 |
|  | #1085 | <p>7/8" x 1-1/2" Sharp</p> <p><i>Minimum profile inside dimensions: 0.700" X 1.326" / Corner radius: 0.157" / Fits internally / Extends 0.910" into the profile / Total height: 2.410".</i></p> | 11 lbs | 400 |
| | #1159 | <p>7/8" x 1-1/2" Sharp</p> <p><i>Minimum profile inside dimensions: 0.745" X 1.362" / Corner radius: 0.150" / Fits internally / Extends 0.915" into the profile / Total height: 2.420".</i></p> | 12 lbs | 400 |
| Patented!  | #1055 | <p>7/8" x 1-1/2" Self-Locking Sharp</p> <p><i>Minimum profile inside dimensions: 0.700" X 1.326" / Wall: 0.080" / Corner radius: 0.157" / Fits internally / Extends 0.910" into the profile / Total height: 2.410".</i></p> <p>U.S. Patent #6,561,499</p> | 14 lbs | 400 |
|  | #1066 | <p>7/8" x 3" Sharp</p> <p><i>Minimum profile inside dimensions: 0.695" X 2.825" / Corner radius: 0.188" / Fits internally / Extends 0.900" into the profile / Total height: 2.900".</i></p> | 16 lbs | 250 |
| | #1066A | <p>7/8" x 3" Sharp</p> <p><i>Minimum profile inside dimensions: 0.745" X 2.880" / Corner radius: 0.188" / Fits internally / Extends 0.900" into the profile / Total height: 2.900".</i></p> | 18 lbs | 250 |
| Patented!  | #1056 | <p>7/8" x 3" Self-Locking Sharp</p> <p><i>Minimum profile inside dimensions: 0.695" X 2.825" / Wall: 0.070" / Corner radius: 0.188" / Fits internally / Extends 0.900" into the profile / Total height: 2.900".</i></p> <p>U.S. Patent #6,561,499</p> | 17 lbs | 250 |

TO ORDER: Call 888-570-5252 ext. 74, Fax: 609-989-1199, Email: orders@lmtproducts.com

PICKET CAPS

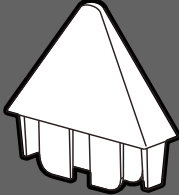

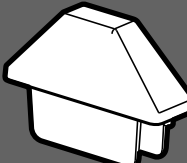
| | Product No. | Description | Box Wt. | Box Qty. |
|---|-------------|---|---------|----------|
|  | #1075 | 7/8" x 3-1/2" Sharp <i>Minimum profile inside dimensions: 0.745" X 3.380" / Wall: 0.070" / Corner radius: 0.125" / Fits internally / Extends 0.875" into the profile / Total height: 2.765".</i> | 18 lbs | 250 |
|  | #1338 | 1-1/4" x 1-1/4" Sharp <i>Minimum profile inside dimensions: 1.040" x 1.040" / Wall: 0.060" / Corner radius: 0.125" / Fits internally / Extends 0.500" into the profile / Total height: 1.180".</i> | 8 lbs | 500 |
| | #1116 | 1-3/8" x 1-3/8" Sharp <i>Maximum profile inside dimensions: 1.197" X 1.197" / Wall: 0.050" / Corner radius: 0.125" / Fits internally / Extends 0.502" into the profile / Total height: 1.228".</i> | 9 lbs | 500 |
| | #1068 | 1-1/2" x 1-1/2" Sharp <i>Minimum profile inside dimensions: 1.330" X 1.330" / Wall: 0.080" / Corner radius: 0.094" / Fits internally / Extends 0.560" into the profile / Total height: 1.325".</i> | 11 lbs | 500 |
| | #1074 | 1-1/2" x 1-1/2" Sharp <i>Minimum profile inside dimensions: 1.370" X 1.370" / Wall: 0.065" / Corner radius: 0.094" / Fits internally / Extends 0.475" into the profile / Total height: 1.325".</i> | 11 lbs | 500 |
| | #1133 | 1-1/2" x 1-1/2" Sharp <i>Minimum profile inside dimensions: 1.371" X 1.371" / Wall: 0.067" / Corner radius: 0.188" / Fits internally / Extends 0.500" into the profile / Total height: 1.520".</i> | 11 lbs | 500 |
| | #1341 | 1-1/2" x 1-1/2" Sharp <i>Minimum profile inside dimensions: 1.390" x 1.390" / Wall: 0.080" / Corner radius: 0.125" / Fits internally / Extends 0.500" into the profile / Total height: 1.300".</i> | 8 lbs | 350 |
|  | #1012-A | 7/8" x 3" Dog Ear <i>Minimum profile inside dimensions: 0.718" X 2.788" / Corner radius: 0.172" / Fits internally / Extends 0.700" into the profile / Total height: 1.700".</i> | 25 lbs | 400 |
| | #1012-B | 7/8" x 3" Dog Ear <i>Minimum profile inside dimensions: 0.718" X 2.826" / Corner radius: 0.172" / Fits internally / Extends 0.700" into the profile / Total height: 1.700".</i> | 25 lbs | 400 |
| | #1012-C | 7/8" x 3" Dog Ear <i>Minimum profile inside dimensions: 0.758" X 2.865" / Corner radius: 0.172" / Fits internally / Extends 0.700" into the profile / Total height: 1.700".</i> | 25 lbs | 400 |

TO ORDER: Call 888-570-5252 ext. 74, Fax: 609-989-1199, Email: orders@lmtproducts.com

PICKET CAPS







| | Product No. | Description | Box Wt. | Box Qty. |
|--|------------------|--|---------|----------|
| | #1206-SL | 7/8" x 3" Self-Locking Dog Ear <i>Minimum profile inside dimensions: .875" X 3.000" / Corner radius: 0.188 / Fits internally / Extends 0.900" into the profile / Total height: 1.980".</i> U.S. Patent #6,561,499 | 17 lbs | 300 |
| | #1049-A | 7/8" x 6" Dog Ear <i>Minimum profile inside dimensions: 0.766" X 5.860" / Corner radius: 0.120" / Fits internally / Extends 0.890" into the profile / Total height: 1.890".</i> | 14 lbs | 125 |
| | #1049-B | 7/8" x 6" Dog Ear <i>Minimum profile inside dimensions: 0.722" X 5.860" / Corner radius: 0.120" / Fits internally / Extends 0.890" into the profile / Total height: 1.890".</i> | 14 lbs | 125 |
| | #1058 | 7/8" x 6" Self-Locking Dog Ear <i>Minimum profile inside dimensions: 0.766" X 5.860" / Wall: 0.080" / Corner radius: 0.120" / Fits internally / Extends 0.890" into the profile / Total height: 1.890".</i> U.S. Patent #6,561,499 | 13 lbs | 125 |
| | #1067 | 7/8" x 6" Self-Locking Dog Ear <i>Minimum profile inside dimensions: 0.722" X 5.860" / Wall: 0.080" / Corner radius: 0.120" / Fits internally / Extends 0.890" into the profile / Total height: 1.890".</i> | 14 lbs | 125 |
| | #1013 | 1" x 6" Dog Ear <i>Minimum profile inside dimensions: 0.815" X 5.740" / Wall: 0.080" / Corner radius: 0.125" / Fits internally / Extends 0.700" into the profile / Total height: 1.700".</i> | 16 lbs | 150 |
| | #1044 | 1" x 1" Gothic <i>Maximum profile outside dimensions: 1.010" X 1.010" / Corner radius: Square / Fits externally / Extends 0.450" over the profile / Total height: 1.875".</i> | 16 lbs | 500 |
| | #1371 | 1-1/2" x 1-1/2" Gothic <i>Maximum profile outside dimensions 1.510" x 1.510" / Corner radius: 0.125" / Fits externally / Extends 0.400" over the profile / Total height: 2.980".</i> | 12 lbs | 200 |

Now Available - LMT Adhesive. See page 75.

TO ORDER: Call 888-570-5252 ext. 74, Fax: 609-989-1199, Email: orders@lmtproducts.com

PICKET CAPS



| | Product No. | Description | Box Wt. | Box Qty. |
|---|-------------|--|---------|----------|
|  | #1048 | 1-1/2" Beveled Cap <i>Maximum profile dimensions: 1.525" X 1.525" / Corner radius: 0.094" / Fits externally / Extends 0.310" over profile / Total height 0.860".</i> | 14 lbs | 850 |
| | #1047 | 2" Beveled Cap <i>Maximum profile dimensions: 2.040" X 2.040" / Corner radius: 0.125" / Fits externally / Extends 0.310" over profile / Total height 1.150".</i> | 14 lbs | 400 |
|  | #1021 | 1" x 1" Boyscout <i>Maximum profile dimensions: 1.010" X 1.010" / Corner radius: Square / Fits externally / Extends 1.000" over the profile / Total height: 4.160".</i> | 23 lbs | 300 |
| | #1339 | 1-1/4" x 1-1/4" Boyscout <i>Maximum profile dimensions: 1.255" X 1.255" / Corner radius: Square / Fits externally / Extends 0.750" over the profile / Total height: 4.500".</i> | 13 lbs | 150 |
|  | #1022 | 1" x 1" Arrowhead <i>Maximum profile dimensions: 1.010" X 1.010" / Corner radius: Square / Fits externally / Extends 0.750" over the profile / Total height: 4.160".</i> | 23 lbs | 300 |
| | #1340 | 1-1/4" x 1-1/4" Arrowhead <i>Maximum profile dimensions: 1.255" X 1.255" / Corner radius: Square / Fits externally / Extends 1.000" over the profile / Total height: 5.000".</i> | 13 lbs | 140 |
|  | #1198 | 1" x 1" Lance <i>Maximum profile dimensions: 1.010" X 1.010" / Corner radius: 0.125" / Fits externally / Total height: 7.640" / Overall outside dimensions: 3.065" X 1.700".</i> | 19 lbs | 100 |
| | #1197 | 1-1/4" x 1-1/4" Lance <i>Maximum profile dimensions: 1.260" X 1.260" / Corner radius: 0.125" / Fits externally / Total height: 7.640" / Overall outside dimensions: 3.065" X 1.700".</i> | 14 lbs | 100 |
|  | #1200 | 1" x 1" Spear <i>Maximum profile dimensions: 1.010" X 1.010" / Corner radius: 0.125" / Fits externally / Total height: 6.920" / Overall outside dimensions: 3.740" X 2.010".</i> | 15 lbs | 100 |
| | #1199 | 1-1/4" x 1-1/4" Spear <i>Maximum profile dimensions: 1.260" X 1.260" / Corner radius: 0.125" / Fits externally / Total height: 6.920" / Overall outside dimensions: 3.740" X 2.010".</i> | 15 lbs | 100 |

TO ORDER: Call 888-570-5252 ext. 74, Fax: 609-989-1199, Email: orders@lmtproducts.com

PICKET CAPS

| | Product No. | Description | Box Wt. | Box Qty. |
|---|-------------|---|---------|----------|
|  | #1202 | 1" x 1" Dagger <i>Maximum profile dimensions: 1.010" X 1.010" / Corner radius: 0.125" / Fits externally / Total height: 6.645" / Overall outside dimensions: 2.350" X 1.700".</i> | 16 lbs | 100 |
| | #1201 | 1-1/4" x 1-1/4" Dagger <i>Maximum profile dimensions: 1.260" X 1.260" / Corner radius: 0.125" / Fits externally / Total height: 6.645" / Overall outside dimensions: 2.350" X 1.700".</i> | 16 lbs | 100 |

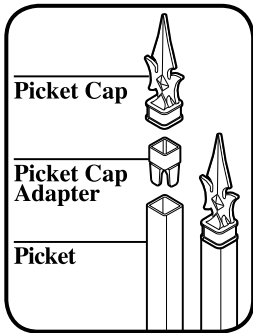

Colors are available. See page 3.

Our Picket Caps adapt to many profiles by using the Picket Cap Adapters. See page 22 for more information.



Lances/ Spears/Daggers with Rings (see p. 19, 62)

TO ORDER: Call 888-570-5252 ext. 74, Fax: 609-989-1199, Email: orders@lmtproducts.com

WELDABLE PICKET CAPS

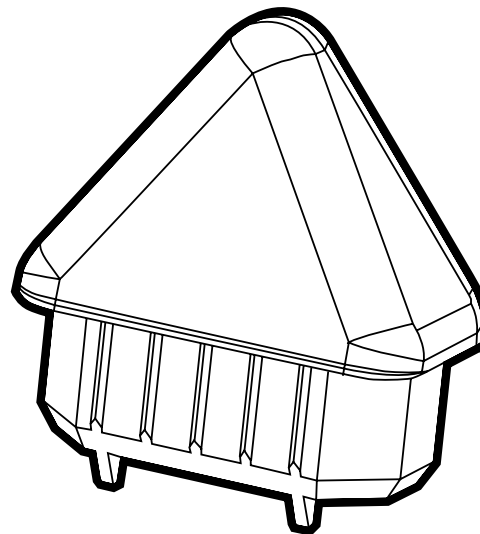
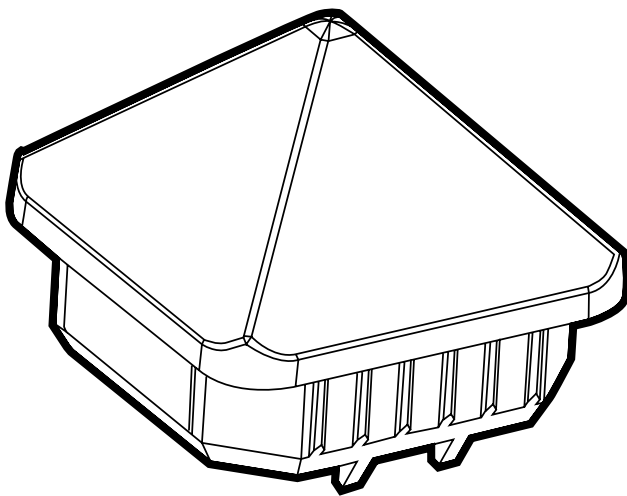

The ultrasonically weldable picket cap from LMT Mercer Group's is the latest innovation designed to save our customers time and money in fence section fabrication. The ultrasonically weldable picket caps were first introduced to customers in 2006 in conjunction with Fence Masters Technology, Inc. using their Picket Master tm machinery.

The patented (patent # US 7,204,898) LMT Mercer Group, Inc ultrasonically weldable picket caps are automatically welded onto your picket extrusions using custom designed caps with "ultrasonic energy directors". The weldable picket caps eliminate the need for messy glue and expensive labor. Customers interested in weldable picket caps are asked to contact LMT Mercer Group, Inc Customer Service, as there are specific requirements to fit each extrusion manufacturers picket extrusion profile dimensions.

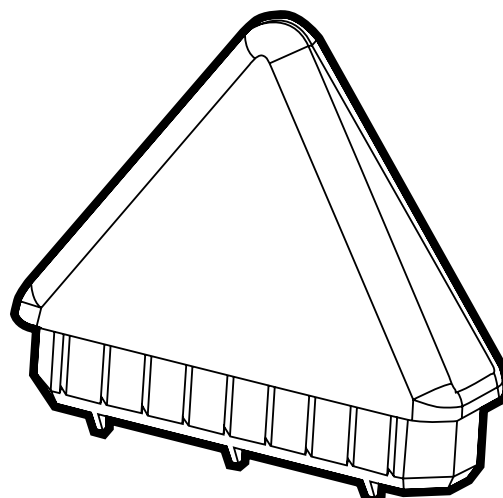
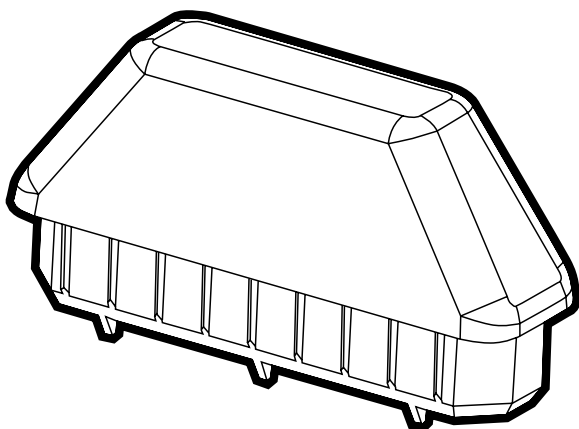



Another innovative system for the PVC fence industry from FMT.

Now you can eliminate the headaches from your current picket/cap assembly system. No more messy, expensive glue! No glue cure time! No fumes! No expensive labor!

The new **PICKET MASTER™** assembly system eliminates major production bottlenecks by combining innovative automation with state-of-the-art plastics "welding." The system creates a fast, economical method for assembling pickets, caps and notching.

- The **PICKET MASTER™** is fully adjustable for a quick and simple change of picket lengths 8" to 72".
- The machine utilizes a comparably priced new picket cap designed exclusively for the **PICKET MASTER™**. The picket cap was created with energy directors to produce a strong, fast "welded" joint. The caps are available in 1" or 3" sizes.
- The machines are fully computer controlled and have a fast 5 second cycle time. That means one operator could produce up to 720 pickets per hour!
- The unique "welding" system is almost instantaneous and makes a strong, permanent joint. No objectionable marking is evident on the picket or cap. The machine's EZ load picket hopper and clamps are lined with non-marking nylon or polycarbonate material to prevent scratching of the parts during processing. Parts are automatically ejected to a holding bin.
- "Welding" or bonding is achieved by using high frequency frictional heat, the assembly process is environmentally safe, and the bond or "welds" produced are clean and consistent.



MODEL PM-II.....call for pricing
Automatic Cap Welding For Multiple Size Pickets. Automatic Notching. Vertical Hopper for Feeding Caps & Pickets.

Option:
Cap Loader and Notching Head For Different Picket Size.....call for pricing

MODEL PM-II Junior.....call for pricing
Automatic Cap Welding For Multiple Size Pickets. Automatic Notching. Manual Feed for Pickets.



DESIGNED AND MANUFACTURED IN THE U. S. A.

22 Corbin Avenue, Bay Shore, New York 11706
P: 631.586.4931 / 800.786.0086 F: 631.586.0939

PICKET CAP ADAPTERS

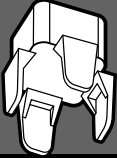
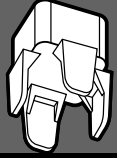
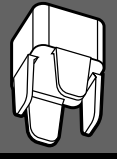
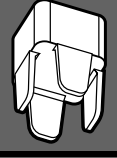
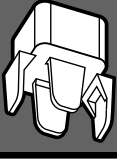
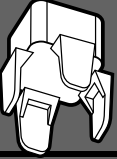
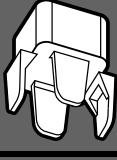
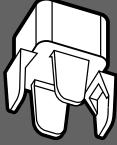

| | Product No. | Description | Box Wt. | Box Qty. |
|---|-------------|--|---------|----------|
|  | #1293A | 1" x 1" to 1-1/2" x 1-1/2" Picket Cap Adapter <i>Fits internally into fence that has minimum picket I.D. dimensions: 1.360" X 1.360" / Fits internally into picket cap.</i> | 10 lbs | 400 |
|  | #1293B | 1" x 1" to 1-3/8" x 1-3/8" Picket Cap Adapter <i>Fits internally into fence picket I.D. dimensions: 1.187" X 1.187" / Fits internally into picket cap.</i> | 10 lbs | 400 |
|  | #1293C | 1" x 1" to 1-1/4" x 1-1/4" Picket Cap Adapter <i>Fits internally into fence picket I.D. dimensions: 1.020" X 1.020" / Fits internally into picket cap.</i> | 10 lbs | 400 |
|  | #1293D | 1" x 1" to 1-1/4" x 1-1/4" Picket Cap Adapter <i>Fits internally into fence picket I.D. dimensions: 1.060" X 1.060" / Fits internally into picket cap.</i> | 10 lbs | 400 |
|  | #1293E | 1" x 1" to 3/4" x 1-1/2" Picket Cap Adapter <i>Fits internally into fence picket I.D. dimensions: 0.562" X 1.320" / Fits internally into picket cap.</i> | 10 lbs | 400 |
|  | #1293F | 1" x 1" to 1-1/2" x 1-1/2" Picket Cap Adapter <i>Fits internally into fence picket I.D. dimensions: 1.320" X 1.320" / Fits internally into picket cap.</i> | 10 lbs | 400 |
|  | #1293G | 1" x 1" to 7/8" x 1-1/2" Picket Cap Adapter <i>Fits internally into fence picket I.D. dimensions: 0.735" X 1.350" / Fits internally into picket cap.</i> | 10 lbs | 400 |
|  | #1293H | 1" x 1" to 7/8" x 1-1/2" Picket Cap Adapter <i>Fits internally into fence picket I.D. dimensions: 0.690" X 1.315" / Fits internally into picket cap.</i> | 10 lbs | 400 |

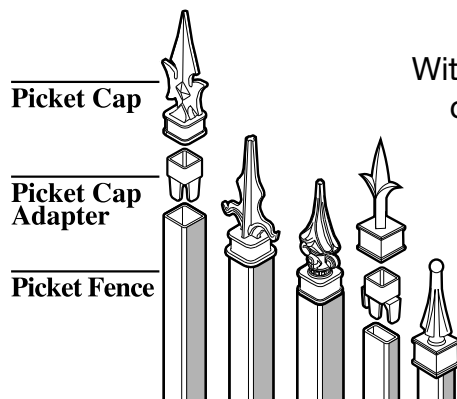







With LMT's New Picket Cap Adapters, you can connect a variety of our decorative Picket Caps to a wide range of profile shapes and sizes. The Adapters are completely hidden from view, for the ultra clean look.

TO ORDER: Call 888-570-5252 ext. 74, Fax: 609-989-1199, Email: orders@lmtproducts.com

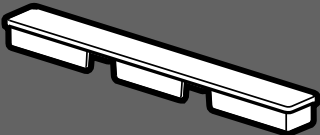
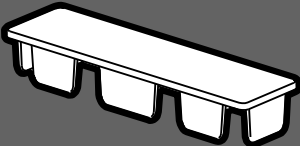
RAIL CAPS

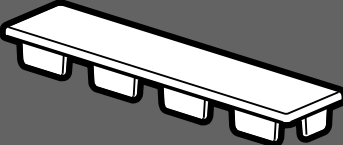

| | Product No. | Description | Box Wt. | Box Qty. |
|---|-------------|---|---------|----------|
|  | #1014 | 1" x 4" <i>Minimum profile inside dimensions: 0.850" X 3.820" / Wall: 0.060" / Corner radius: 0.156" / Fits internally / Extends 0.410" into the profile / Total height: 0.500".</i> | 25 lbs | 800 |
|  | #1018 | 1" x 6" <i>Minimum profile inside dimensions: 0.815" X 5.720" / Wall: 0.090" / Corner radius: 0.156" / Fits internally / Extends 0.400" into the profile / Total height: 0.530".</i> | 39 lbs | 750 |
|  | #1015 | 1" x 8" <i>Minimum profile inside dimensions: 0.830" X 7.830" / Wall: 0.080" / Corner radius: 0.094" / Fits internally / Extends 0.370" into the profile / Total height: 0.500".</i> | 29 lbs | 400 |
|  | #1052 | 1-1/2" x 5-1/2" <i>Minimum profile inside dimensions: 1.275" X 5.300" / Wall: 0.100" / Corner radius: 0.156" / Fits internally / Extends 0.620" into the profile / Total height: 0.720".</i> | 22 lbs | 400 |
|  | #1016 | 2" x 3-1/2" <i>Minimum profile inside dimensions: 1.710" X 3.215" / Wall: 0.130" / Corner radius: 0.172" / Fits internally / Extends 0.500" into the profile / Total height: 0.615".</i> | 39 lbs | 650 |
| | #1050 | 2" x 3-1/2" <i>Minimum profile inside dimensions: 1.780" X 3.300" / Wall: 0.120" / Corner radius: 0.250" / Fits internally / Extends 0.620" into the profile / Total height: 0.720".</i> | 31 lbs | 500 |
|  | #1017 | 2" x 8" <i>Minimum profile inside dimensions: 1.700" X 7.720" / Wall: 0.150" / Corner radius: 0.109" / Fits internally / Extends 0.500" into the profile / Total height 0.650".</i> | 38 lbs | 240 |
|  | #1076 | 7/8" x 1-1/2" End Cap <i>Maximum profile dimensions: .893" X 1.490" / Corner radius: 0.125" / Fits externally / Extends 0.995" over the profile / Total height 1.061".</i> | 13 lbs | 500 |

Now Available - LMT Adhesive. See page 75.

TO ORDER: Call 888-570-5252 ext. 74, Fax: 609-989-1199, Email: orders@lmtproducts.com

RAIL CAPS

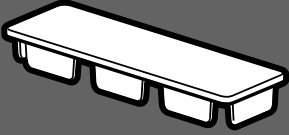
| | Product No. | Description | Box Wt. | Box Qty. |
|---|-------------|---|---------|----------|
|  | #1051 | 2" x 6" <i>Minimum profile inside dimensions: 1.810" X 5.845" / Wall: 0.100" / Corner radius: 0.156" / Fits internally / Extends 0.630" into the profile / Total height: 0.730".</i> | 16 lbs | 200 |
| | #1170A | 2" x 6" <i>Minimum profile inside dimensions: 1.783" X 5.773" / Wall: 0.100" / Corner radius: 0.219" / Fits internally / Extends .625" into the profile / Total height: 0.725".</i> | 12 lbs | 150 |
| | #1170B | 2" x 6" <i>Minimum profile inside dimensions: 1.750" X 5.738" / Wall: 0.100" / Corner radius: 0.219" / Fits internally / Extends 0.625" into the profile / Total height: 0.725".</i> | 11 lbs | 150 |
| | #1170C | 2" x 6" <i>Minimum profile inside dimensions: 1.722" X 5.707" / Wall: 0.100" / Corner radius: 0.219" / Fits internally / Extends .625" into the profile / Total height: 0.725".</i> | 11 lbs | 150 |
| | #1170D | 2" x 6" <i>Minimum profile inside dimensions: 1.722" X 5.738" / Wall: 0.100" / Corner radius: 0.219" / Fits internally / Extends 0.625" into the profile / Total height: 0.725".</i> | 11 lbs | 150 |

TO ORDER: Call 888-570-5252 ext. 74, Fax: 609-989-1199, Email: orders@lmtproducts.com

DECK & RAIL COMPONENTS

LMT Mercer Group, Inc. offers one of the most comprehensive assortments of deck and rail components in the industry. We have been working diligently to create deck and rail components that meet or exceed AC174 standards. Besides offering a wide assortment of injection-molded and thermo-formed spindles, we can also create custom thermo-formed spindles upon request. Our innovative products like the Round Post Adapters and the Storm Kits allow you to construct high-quality, durable decks and rail systems that customers will be able to enjoy for years to come.



Spindles, Porch Posts & Accessories

Brackets

Post Skirts

Post Accents

Rail Mounts

Spaghetti Rail



 LMT Mercer Group, Inc.

DECK & RAIL COMPONENTS

LMT Mercer Group, Inc. offers one of the most comprehensive assortments of deck and rail components in the industry. We have been working diligently to create deck and rail components that meet or exceed AC174 standards. Besides offering a wide assortment of injection-molded and thermo-formed spindles, we can also create custom thermo-formed spindles upon request. Our innovative products like the Round Post Adapters and the Storm Kits allow you to construct high-quality, durable decks and rail systems that customers will be able to enjoy for years to come.



Spindles, Porch Posts & Accessories

Brackets

Post Skirts

Post Accents

Rail Mounts

Spaghetti Rail



 LMT Mercer Group, Inc.

INJECTION-MOLDED SPINDLES



| | Product No. | Description | Box Wt. | Box Qty. |
|--|--------------|--|---------|----------|
| | #3002 | 1-1/4" x 1-1/4" x 32" Colonial <i>Corner radii are .160R / Length tolerance + / - 1/8" / Custom lengths from 27-1/2" to 32" are available.</i> | 73 lbs | 66 |
| | #3005 | 1-1/4" x 1-1/4" x 34" Colonial <i>Corner radii are .160R / Length tolerance + / - 1/8". Custom lengths from 27-1/2" to 34" are available.</i> | 73 lbs | 66 |
| | #3000 | 1-1/2" x 1-1/2" x 32" Colonial <i>Corner radii are .180R / Length tolerance + / - 1/8". Custom lengths from 27-1/2" to 38" are available.</i> | 69 lbs | 50 |
| | #3001 | 1-1/2" x 1-1/2" x 38" Colonial <i>Corner radii are .180R / Length tolerance + / - 1/8". Custom lengths from 27-1/2" to 38" are available.</i> | 81 lbs | 50 |

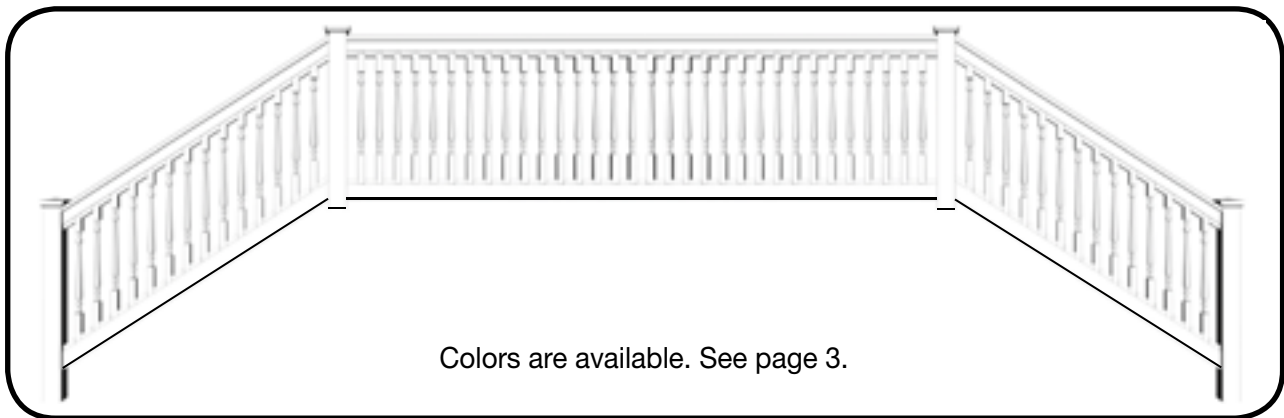

Colors are available. See page 3.

TO ORDER: Call 888-570-5252 ext. 74, Fax: 609-989-1199, Email: orders@lmtproducts.com

THERMO-FORMED SPINDLES



Thermo-Formed Spindles only – LMT Almond, LMT Khaki, LMT Beige have a 25% up charge over White. Custom Colors - 30% up charge. 6-8 week lead time. 20,000 parts minimum. Custom lengths and End cuts for any color: \$.10 to \$.50 per side, depending on volume. For custom lengths, contact Customer Service.

| | Product No. | Description | Box Wt. | Box Qty. |
|--|----------------|---|---------|----------|
| | #3100-32.5 | 1-1/2" x 1-1/2" x 32-1/2" Thermo-Formed Spindle <i>Corner radii are .220R / Length tolerance + / - 1/8" / Custom lengths from 27-1/2" to 32-1/2" are available.</i> | 32 lbs | 50 |
| | #3100-32.5-600 | 1-1/2" x 1-1/2" x 32-1/2" - (Gaylord-Bundles) Thermo-Formed Spindle <i>Corner radii are .220R / Length tolerance + / - 1/8" / Custom lengths from 27-1/2" to 32-1/2" are available.</i> | 405 lbs | 600 |
| | #3100-36.5 | 1-1/2" x 1-1/2" x 36-1/2" Thermo-Formed Spindle <i>Corner radii are .220R / Length tolerance + / - 1/8" / Custom lengths from 32-1/2" to 39" are available.</i> | 37 lbs | 50 |
| | #3100-36.5-600 | 1-1/2" x 1-1/2" x 36-1/2" - (Gaylord-Bundles) Thermo-Formed Spindle <i>Corner radii are .220R / Length tolerance + / - 1/8" / Custom lengths from 32-1/2" to 39" are available.</i> | 444 lbs | 600 |
| | #3140-34 | 1-1/4" x 1-1/4" x 34" - Colonial <i>Corner radii are .180R / Length tolerance + / - 1/8" / Custom lengths from 27-1/2" to 39" are available.</i> | 44 lbs | 66 |
| | #3140-34-720 | 1-1/4" x 1-1/4" x 34" - Colonial (Gaylord-Bundles) <i>Corner radii are .180R / Length tolerance + / - 1/8" / Custom lengths from 27-1/2" to 39" are available.</i> <i>Same style as #3005 Colonial Injection-Molded Spindle.</i> | 480 lbs | 720 |

TO ORDER: Call 888-570-5252 ext. 74, Fax: 609-989-1199, Email: orders@lmtproducts.com

THERMO-FORMED SPINDLES



Thermo-Formed Spindles only – LMT Almond, LMT Khaki, LMT Beige have a 25% up charge over White. Custom Colors - 30% up charge. 6-8 week lead time. 20,000 parts minimum. Custom lengths and End cuts for any color: \$.10 to \$.50 per side, depending on volume. For custom lengths, contact Customer Service.

| | Product No. | Description | Box Wt. | Box Qty. |
|--|-----------------------|---|---------|----------|
| | #3110-30.4 | 1-1/2" x 1-1/2" x 30-3/8" Thermo-Formed Spindle <i>Corner radii are .266R / Length tolerance + / - 1/8"</i> <i>Custom lengths from 27-1/2" to 32-1/2" are available.</i> | 24 lbs | 50 |
| | #3110-30.4-600 | 1-1/2" x 1-1/2" x 30-3/8" - (Gaylord-Bundles) Thermo-Formed Spindle <i>Corner radii are .266R / Length tolerance + / - 1/8"</i> <i>Custom lengths from 27-1/2" to 32-1/2" are available.</i> | 300 lbs | 600 |
| | #3120-36.4 | 1-1/2" x 1-1/2" x 36-3/8" Thermo-Formed Spindle <i>Corner radii are .219R / Length tolerance + / - 1/8"</i> <i>Custom lengths from 27-1/2" to 39" are available.</i> | 32 lbs | 50 |
| | #3120-36.4-600 | 1-1/2" x 1-1/2" x 36-3/8" - (Gaylord-Bundles) Thermo-Formed Spindle <i>Corner radii are .219R / Length tolerance + / - 1/8"</i> <i>Custom lengths from 27-1/2" to 39" are available.</i> | 400 lbs | 600 |

TO ORDER: Call 888-570-5252 ext. 74, Fax: 609-989-1199, Email: orders@lmtproducts.com

THERMO-FORMED SPINDLES



| | Product No. | Description | Box Wt. | Box Qty. |
|--|-------------------------|---|---------|----------|
| | #3150-32 | 1-1/2" x 1-1/2" x 32" - Colonial Thermo-Formed Spindle <i>Corner radii are .180R / Length tolerance +/- 1/8" / Custom lengths from 27-1/2" to 39" are available.</i> | 32 lbs | 50 |
| | #3150-32-600 | 1-1/2" x 1-1/2" x 32" - (Gaylord-Bundles) Colonial Thermo-Formed Spindle <i>Corner radii are .180R / Length tolerance +/- 1/8" / Custom lengths from 27-1/2" to 39" are available.</i> | 410 lbs | 600 |
| | #3150-38 | 1-1/2" x 1-1/2" x 38" - Colonial Thermo-Formed Spindle <i>Corner radii are .180R / Length tolerance +/- 1/8" / Custom lengths from 27-1/2" to 39" are available.</i> | 37 lbs | 50 |
| | #3150-38-600 | 1-1/2" x 1-1/2" x 38" - (Gaylord-Bundles) Colonial Thermo-Formed Spindle <i>Corner radii are .180R / Length tolerance +/- 1/8" / Custom lengths from 27-1/2" to 39" are available.</i> | 450 lbs | 600 |
| | #3130-32 | 1.295" x 1.295" x 32" - Thermo-Formed Spindle <i>Corner radii are .204R / Length tolerance +/- 1/8" / Custom lengths from 27-1/2" to 33" are available.</i> | 30 lbs | 50 |
| | #3130-32-600 | 1.295" x 1.295" x 32" - (Gaylord-Bundles) Thermo-Formed Spindle <i>Corner radii are .204R / Length tolerance +/- 1/8" / Custom lengths from 27-1/2" to 33" are available.</i> | 490 lbs | 800 |

TO ORDER: Call 888-570-5252 ext. 74, Fax: 609-989-1199, Email: orders@lmtproducts.com

NEWEL AND PORCH POSTS



| | Product No. | Description | Box Wt. | Box Qty. |
|--|-------------|--|---------|----------|
| | #3021 | 4" x 4" x 108" Porch Post <i>Includes structural mounting hardware / Corner radii are .40625R / Length tolerance +/- 1/2".</i> Weight Rating: 3,400 LBS Engineering Data Available | 25 lbs | 1 |
| | #3022 | 5" x 5" x 108" Porch Post <i>Includes structural mounting hardware / Corner radii are .40625R / Length tolerance +/- 1/2".</i> Weight Rating: 5,000 LBS Engineering Data Available | 30 lbs | 1 |
| | #3020 | 4" x 4" x 48" Newel Post <i>Corner radii are .375R / Length tolerance +/- 1/2".</i> Works great with post surface mounts. | 5 lbs | 1 |

Newel and Porch Posts sold individually.

White and LMT Almond in stock, Almond 20% upcharge.
 LMT Khaki and Beige available by special order in pallet quantities, 20% upcharge.

*** Porch and Newel posts are designed to match the look of our Colonial Spindles. ***

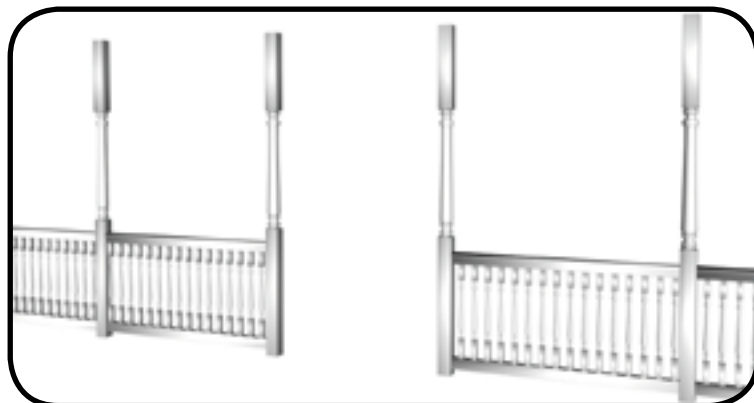

TO ORDER: Call 888-570-5252 ext. 74, Fax: 609-989-1199, Email: orders@lmtproducts.com

STORM KITS

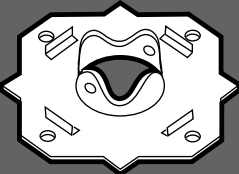
| | Product No. | Description | Box Wt. | Box Qty. |
|---|-------------|---|---------|----------|
|  | #3023 | 4" Storm Kit <i>The mounting plate for porch posts includes one top and one bottom mounting plate, two decorative skirts and mounting screws.</i> | 2 lbs | 1 |
| | #3024 | 5" Storm Kit <i>The mounting plate for porch posts includes one top and one bottom mounting plate, two decorative skirts and mounting screws.</i> | 3 lbs | 1 |

STORM KIT INSTALLATION INSTRUCTIONS (Porch Posts)

STORM KIT PARTS LIST

- 2 - plates
- 8 - trim pieces (top & bottom)
- 4 - #10 x 1" screws

INSTALLATION INSTRUCTIONS

- Step 1: Insert top and bottom aluminum plate on post.
- Step 2: Refer to drawing and pre-drill holes with $\frac{1}{8}$ " drill bit. Using screws provided insert into pre-drilled holes. (#10 x 1" screws provided)
- Step 3: Install post.
- Step 4: Screw plates to floor and roof. Insert 4 screws into top and bottom plate (not included.)
- Step 5: Snap 4 trim pcs. around top and bottom of post. Friction joints will keep them snug against post. No screws or glue needed.

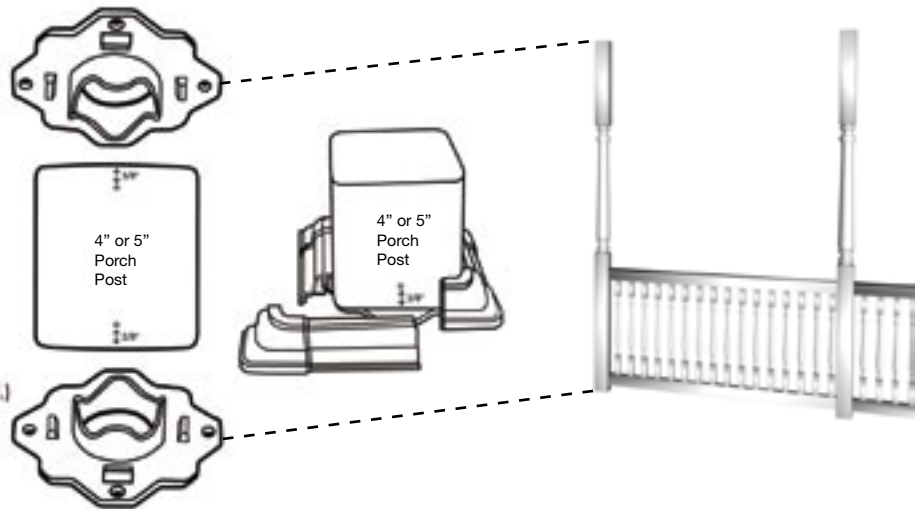

FOOT BLOCK KITS

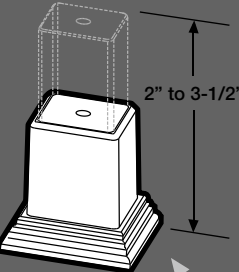
| | Product No. | Description | Box Wt. | Box Qty. |
|---|-------------|---|----------|----------|
|  | #1254 | 2 Piece Foot Block Kit <i>Includes two #10 x 3/4" stainless steel screws and one color matched screw cap.</i> | 14.5 lbs | 50 |
| | #1255 | 3 Piece Foot Block Kit <i>Includes floor mounting plate, three #10 x 3/4" stainless steel screws and one color matched screw cap.</i> | 16 lbs | 50 |

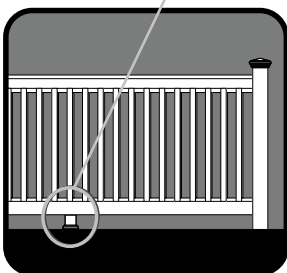









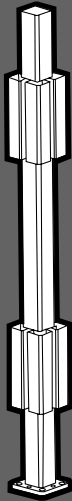

The adjustable Foot Block Kits are designed to support sagging rail or fence sections. It is a two-piece unit which comes pre-assembled & ready to mount. The internal ratchet feature allows the Foot Block to expand from 2.000" to 3.500" in 1/4" increments. The top portion is 1.145" x 1.145" to be screwed into the bottom of a 1-3/8" or wider horizontal rail. The skirt portion of the base measures 2.000" x 2.000". A screw can be installed into the side of the Foot Block for those demanding load applications. All of the components are packaged in a 2 mill heat-sealed polyethylene bag. The Floor Mounting Plate in #1225 is screwed into the deck and is then glued to the Foot Block. Colors are available. See page 3.

POST SURFACE MOUNTS

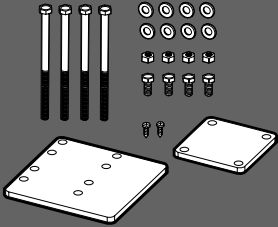
Blu-Mount™ is a post surface mount designed for installing a 4" and 5" post to concrete, wood and composite decking. Blu-Mount™ is designed with an adjustable leveling feature to ensure accurate installation. They are made from Q235 steel with a Dachromate coating for superior rust prevention in even the most severe environments. The aluminum guides are made from 6063 T5 Aluminum alloy. Both the aluminum and PVC guides are designed to function with all wall thickness of 4" and 5" post profiles.

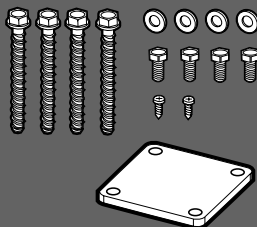
NOTE: Hardware pack #1368 for Wood & Composite applications or #1369 for Concrete applications must be ordered to complete the installation.

| | Product No. | Description | Box Wt. | Box Qty. |
|--|--|---|---------|----------|
|  <p>Patent Pending</p> | #1366A  | Blu-Mount™ 36" Post Mount for 4" Post - Aluminum Guides | 12 lbs | 1 |
| | #1366B  | Blu-Mount™ 36" Post Mount for 5" Post - Aluminum Guides | 12 lbs | 1 |
| | #1366C  | Blu-Mount™ 36" Post Mount for 4" Post - PVC Guides | 12 lbs | 1 |
| | #1367A  | Blu-Mount™ 42" Post Mount for 4" Post - Aluminum Guides | 14 lbs | 1 |
| | #1367B  | Blu-Mount™ 42" Post Mount for 5" Post - Aluminum Guides | 14 lbs | 1 |
| | #1367C  | Blu-Mount™ 42" Post Mount for 4" Post - PVC Guides | 14 lbs | 1 |
|  | #1368  | Blu-Mount™ Post Mount Mounting Hardware - Wood & Composite Applications | 36 lbs | 10 |
|  | #1369  | Blu-Mount™ Post Mount Mounting Hardware - Concrete Applications | 15 lbs | 10 |

TO ORDER: Call 888-570-5252 ext. 74, Fax: 609-989-1199, Email: orders@lmtproducts.com

BLU-MOUNT™

POST MOUNT INSTALLATION INSTRUCTIONS

Step 1

- a. Lay out the location of the post.
- b. Wood Only – Install at least 3” of blocking under the mounting location. Securely attach the blocking using reinforcement screws.

Step 2

- a. Using the leveling plate as a template, mark the locations of the 4 mounting holes to be drilled.
- b. Concrete Only – Drill 4 holes into the concrete using a 1/4” diameter masonry drill bit. The hole must be drilled to a minimum depth of 3-1/2”.
- b. Wood Only – Drill 4 holes through the decking and blocking using a 3/8” diameter drill bit.
- c. Clean out the holes of all dust and debris.

Step 3

- a. Install the 4 leveling bolts into the post mount member.
- b. Place the leveling plate on the concrete or decking surface, as appropriate, and align over the 4 drilled holes.
- c. Place the post mount member on top of the leveling plate and align the 4 holes.
- d. Adjust the leveling screws to ensure the post mount member is level.

Step 4 – Concrete Only

- a. Install the 4 concrete bolts with washers, as shown, by applying downward pressure while turning in a clockwise direction.
- b. Continue to tighten the bolts until the heads are firmly seated. (Do not over tighten.)

Step 4 – Wood Only

- a. Install the 4 mounting bolts with washers, as shown.
- b. On the underside, place the back plate over the exposed mounting bolts. (Use the centered holes for in-line applications and the offset holes for corner applications.)
- c. Secure the back plate by using the supplied mounting nuts and washers.

Step 5

- a. Install the two guide blocks onto the post mount member. They should be positioned so that the screws from the railing brackets will screw into the guide blocks.
- b. Once the proper heights are established, drill a 3/16” diameter hole through both the guide block and the post mount member. Install the supplied guide block screws to hold the guide blocks in place.

Step 6

- a. Install the post profile and rail brackets according to manufacturer specifications.

IMPORTANT:
 Installer must
 consult local code
 officials for
 compliance
 to building code
 requirements.

PATENT PENDING

LMT Mercer Group, Inc.

690 Puritan Avenue
 Lawrenceville, NJ 08648
 P: 1.888.570.5252
 F: 1.609.989.1199
 E: orders@lmtproducts.com
 W: www.lmtproducts.com

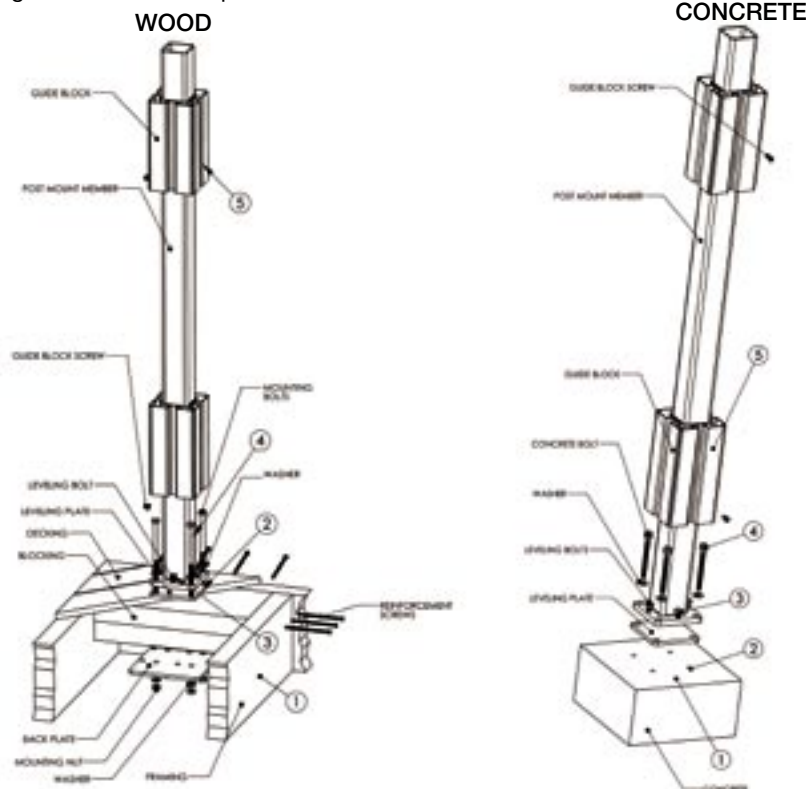

POST SURFACE MOUNTS



| | Product No. | Description | Box Wt. | Box Qty. |
|--|-------------|---|---------|----------|
| | #4006 | 4"x 4"x 24" Post Mount for Wood <i>See Figure A</i> | 12 lbs | 1 |
| | #4005 | 4"x 4"x 24" Post Mount for Concrete <i>See Figure B</i> | 7 lbs | 1 |
| | #4009 | 4"x 4"x 38" Newel Mount for Wood <i>See Figure C</i> | 22 lbs | 1 |
| | #4007 | 4"x 4"x 38" Newel Mount for Concrete <i>See Figure D</i> | 22 lbs | 1 |
| <p>Post Surface Mounts are sold individually. White bottom post skirt is included.</p> <p>CAUTION: NOT ALL MOUNTING SYSTEMS IN THE INDUSTRY ARE TESTED AND/OR PASS THE MINIMUM LOAD REQUIREMENTS. LMT'S WERE TESTED AND PASSED. ASK FOR CERTIFICATIONS.</p> | | | | |

Patent Pending

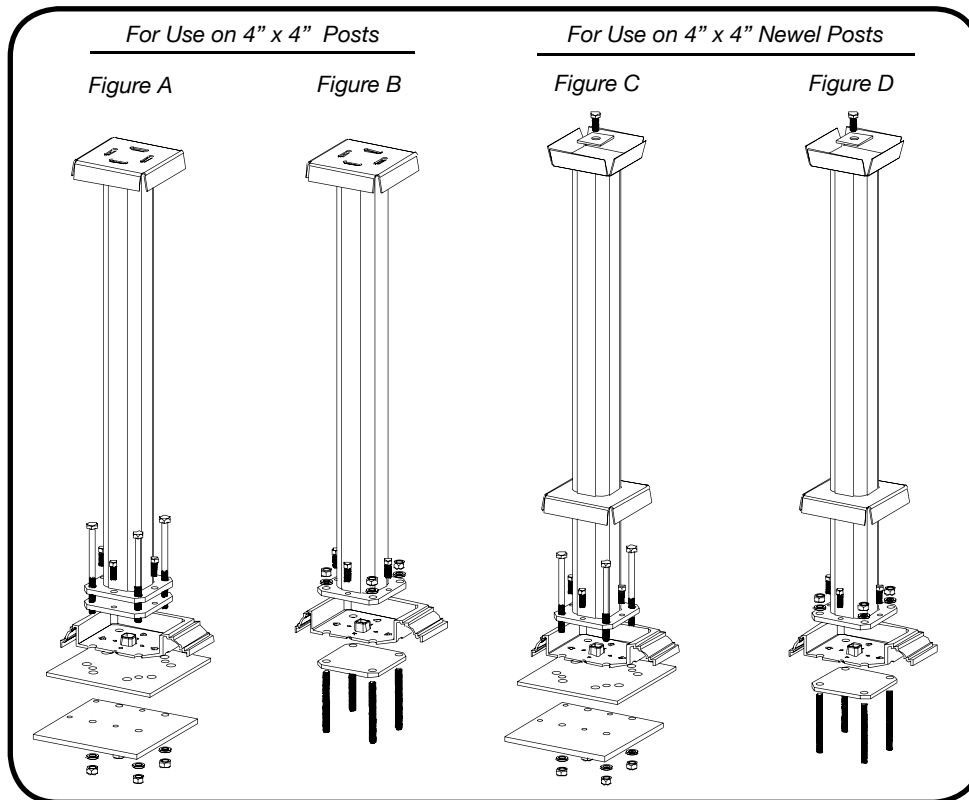

TO ORDER: Call 888-570-5252 ext. 74, Fax: 609-989-1199, Email: orders@lmtproducts.com

ROUND POST ADAPTER

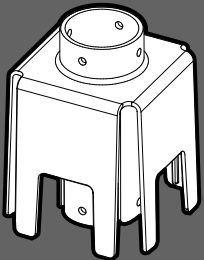
| | Product No. | Description | Box Wt. | Box Qty. |
|---|-------------|--|---------|----------|
|  | #1289A | 4" x 4" w/1-5/8" ID Round Post Adapter | 23 lbs | 48 |
| | #1289B | 4" x 4" w/2" ID Round Post Adapter | 25 lbs | 48 |
| | #1290A | 5" x 5" w/1-5/8" ID Round Post Adapter | 37 lbs | 48 |
| | #1290B | 5" x 5" w/2" ID Round Post Adapter | 39 lbs | 48 |



U.S. Patent
#D552,264

The Rook Post Mount Adapter is a 100% PVC sleeve designed to fill the void between standard sized 1-5/8" or 2" O.D. round pipe and a 4" or 5" vinyl post. The Rook acts as a spacer from the outside wall of the pipe to the wall thicknesses of 4" and 5" vinyl posts. They slide over the round pipe and are fastened with screws. Just slide the vinyl post over The Rook Post Mount Adapters and you have a professionally installed vinyl post.

Benefits:

1. Allows for vinyl post installation in troubled areas.
2. Offers the option of retrofitting chain-link fences to vinyl.
3. Adds flexibility with various wall thicknesses of vinyl posts.
4. Provides the option of no digging and no mess vinyl post installation.

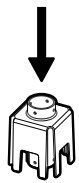

Round Steel Post

Convert from a Round Steel Post to Vinyl

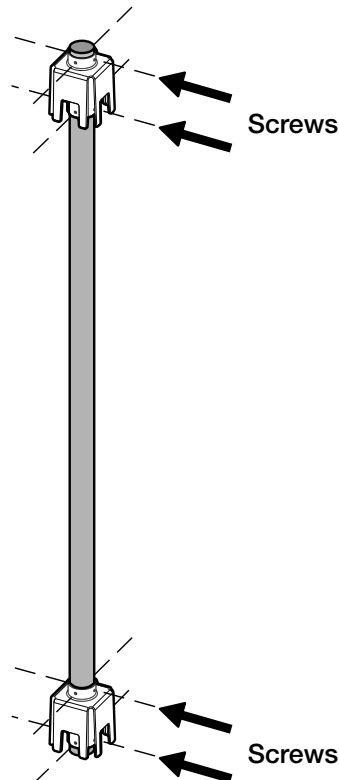

Screws







Screws



Vinyl Post

TO ORDER: Call 888-570-5252 ext. 74, Fax: 609-989-1199, Email: orders@lmtproducts.com

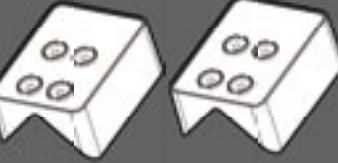



COVERED BRACKET KITS

| | Product No. | Description | Box Wt. | Box Qty. |
|---|--|--|---------|----------|
|  | <p>#1393</p> <p>NEW RELEASE</p> | <p>2" x 3-1/2" Covered Bracket Kit - 2 Piece</p> <p><i>Includes: (2) 2" X 3-1/2" Covers / (2) Nylon Back Plates / (12) #10 X 1-1/4" Pan Head / Phillips Drive / Self Tapping / Stainless Steel Screws.</i></p> | 11 lbs | 30 |
|  | <p>#1394</p> <p>NEW RELEASE</p> | <p>T-Rail Covered Bracket Kit- 2 Piece</p> <p><i>Includes: (1) T-Rail Cover (1) 2" X 3-1/2" Cover / (2) Nylon Back Plates / (12) #10 X 1-1/4" Pan Head / Phillips Drive / Self Tapping / Stainless Steel Screws.</i></p> | 11 lbs | 30 |
|  | <p>#1395</p> <p>NEW RELEASE</p> | <p>2" x 3-1/2" Stair Covered Bracket Kit- 2 Piece</p> <p><i>Includes: (1) Upper 2" X 3-1/2" Rail Cover / (1) Lower 2" X 3-1/2" Rail Cover / (2) Back Plates / (12) #10 X 1-1/4" Pan Head / Phillips Drive / Self Tapping / Stainless Steel Screws.</i></p> | 11 lbs | 30 |
|  | <p>#1396</p> <p>NEW RELEASE</p> | <p>T-Rail Stair Covered Bracket Kit - 2 Piece</p> <p><i>Includes: (1) Upper T-Rail Cover / (1) Lower T-Rail Cover / (2) Back Plates / (12) #10 X 1-1/4" Pan Head / Phillips Drive / Self Tapping / Stainless Steel Screws.</i></p> | 11 lbs | 30 |
|  | <p>#1397</p> <p>NEW RELEASE</p> | <p>2" x 3-1/2" 45 Degree Covered Bracket Kit Adapters</p> <p><i>Includes: (2) 2" X 3-1/2" 45 Degree Adapters.</i></p> | 10 lbs | 30 |
|  | <p>#1398</p> <p>NEW RELEASE</p> | <p>T-Rail 45 Degree Covered Bracket Kit Adapters</p> <p><i>Includes: (2) T-Rail 45 Degree Adapters.</i></p> | 10 lbs | 30 |

TO ORDER: Call 888-570-5252 ext. 74, Fax: 609-989-1199, Email: orders@lmtproducts.com

COVERED BRACKET KITS







| | Product No. | Description | Box Wt. | Box Qty. |
|--|---|---|---------|----------|
|  | #1399  | 2" x 3-1/2" Rail 8" Column Adapter For Covered Bracket Kit <i>Includes: (2) 2" X 3-1/2" Rail 8" Column Adapters.</i> | 10 lbs | 30 |
|  | #1400  | T-Rail 8" Column Adapter For Covered Bracket Kit <i>Includes: (2) T-Rail 8" Column Adapters.</i> | 10 lbs | 30 |

TO ORDER: Call 888-570-5252 ext. 74, Fax: 609-989-1199, Email: orders@lmtproducts.com

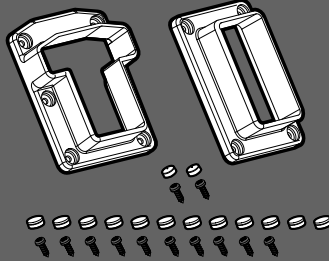
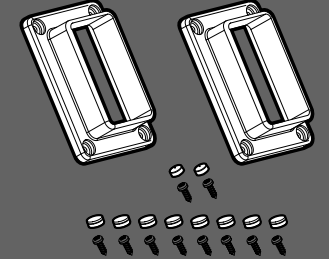
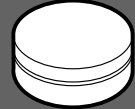
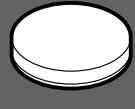
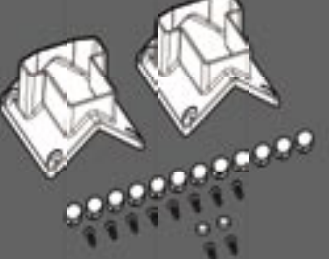
T-RAIL & 2" x 3-1/2" RAIL BRACKET KITS



| | Product No. | Description | Box Wt. | Box Qty. |
|--|-------------|---|---------|--------------|
|  | #1182 | T-Rail Bracket Kit <i>The T-Rail Kit includes:</i> (1) T-Rail Bracket, (1) 2" x 3-1/2" Rail Bracket, (10) #10 x 1-1/4" Phillips Pan Head Screws, (12) PVC Screw Hole Plugs, (2) Self-Drilling Phillips Pan Head Screws (self-drilling in order to drill into the aluminum stiffener), (2) PVC Screw Covers, (1) Instruction Sheet. | 13 lbs | 30 |
|  | #1219 | 2" x 3-1/2" Rail Bracket Kit <i>Includes:</i> (2) 2" x 3-1/2" Rail Brackets, (8) #10 x 1-1/4" Phillips Pan Head Screws, (8) PVC Screw Hole Plugs, (2) Self-Drilling Phillips Pan Head Screws (self-drilling in order to drill into the aluminum stiffener), (2) PVC Screw Covers, (1) Instruction Sheet. | 12 lbs | 30 |
|  | #1181 | Hole Plugs for Standard Bracket Kits <i>.525" DIA x .220" thick/ 12 plugs per tree / 160 trees per box / 1920 hole plugs per box.</i> | 6 lbs | 160 Trees |
|  | #1220 | Hole Plugs for Bracket Kits Using Screw #4033 <i>.525" DIA x .130" Thick/ 12 plugs per tree / 160 trees per box / 1920 hole plugs per box.</i> | 6 lbs | 160 Trees |
|  | #1387 | T-Rail 45 Degree Bracket Kit <i>Includes:</i> (2) T-Rail Brackets / (12) Screw Hole Plugs / (12) #10 x 1-1/4" Phillips Pan Head Screws.  | 8 lbs | 10 |
|  | #1388 | 2" x 3-1/2" 45 Degree Bracket Kit <i>Includes:</i> (2) 2"x3-1/2" Brackets / (12) Screw Hole Plugs / (12) #10 x 1-1/4" Phillips Pan Head Screws.  Colors are available. See page 3. | 7 lbs | 10 |

See page 42 for the maximum T-Rail Bracket profile dimensions / Corner radius: 5/32" / Fits externally / Extends 1.250" over the profile / Overall outside dimensions: 3.731" x 5.000".

The 2" x 3-1/2" Bracket maximum profile dimensions: 2.020" x 3.520" / Corner radius: 5/32" / Fits externally / Extends 1.250" over the profile / Overall outside dimensions: 3.445" x 4.945".



TO ORDER: Call 888-570-5252 ext. 74, Fax: 609-989-1199, Email: orders@lmtproducts.com

STAIR RAIL BRACKET KITS

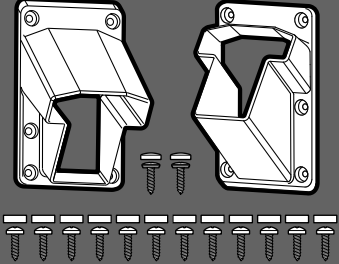
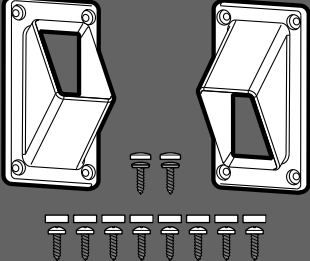

| | Product No. | Description | Box Wt. | Box Qty. |
|---|-------------|--|---------|----------|
|  | #1277 | <p>T-Rail Stair Bracket Kit</p> <p><i>The T-Rail Stair Kit includes:</i> (1) T-Rail Stair Bracket, Top, (1) T-Rail Stair Bracket, Bottom, (12) #10 x 1-1/4" Phillips Pan Head Stainless Steel Screws, (12) PVC Screw Hole Plugs, (2) Self-Drilling Phillips Pan Head Screws (self-drilling in order to drill into the aluminum stiffener), (2) PVC Screw Covers, (1) Instruction Sheet.</p> | 16 lbs | 30 |
|  | #1276 | <p>2" x 3-1/2" Stair Rail Bracket Kit</p> <p><i>The 2" x 3-1/2" Stair Rail Kit includes:</i> (2) 2" x 3-1/2" Stair Rail Brackets, (8) #10 x 1-1/4" Phillips Pan Head Stainless Steel Screws, (8) PVC Screw Hole Plugs, (2) Self-Drilling Phillips Pan Head Screws (self-drilling in order to drill into the aluminum stiffener), (2) PVC Screw Covers, (1) Instruction Sheet.</p> | 14 lbs | 30 |

See page 42 for the maximum T-Rail Bracket profile dimensions / Corner radius: 5/32" / Fits externally / Extends 1.250" over the profile / Overall outside dimensions: 3.731" x 5.000".

The 2" x 3-1/2" Bracket maximum profile dimensions: 2.020" x 3.520" / Corner radius: 5/32" / Fits externally / Extends 1.250" over the profile / Overall outside dimensions: 3.445" x 4.945".

Colors are available. See page 3.

Features:

- **BRACKETS ARE DESIGNED FOR A 35° ANGLE, BUT CAN BE USED FROM A 28° TO 42° ANGLE.**
- Pre-packaged in one heat-sealed heavy gauge poly bag.
- All of the screws are self drilling stainless steel.
- The screws are completely and cleanly hidden from view by the flush mounted Hole Plugs.
- A plastic strip holds the Hole Plugs together. No more lost parts on the ground.
- The Hole Plugs can be installed directly from the plastic strip.
- A "Click" verifies that they are securely in place.
- Two LMT custom screws with screw covers are included to fasten the brackets to the rails.
- The instruction sheets are also available in Spanish.

Due to the revised ICC-ES standard AC174 and the corresponding ASTM D7032-04 and D1761-88 testing procedures, we completely re-engineered our most popular bracket kits. The goal was to create an aesthetically pleasing, easy to install system that would exceed the new ratings for one- and two-family dwellings, as well as residential applications. We achieved this goal without infringing on any current U.S. patents, by making numerous structural enhancements and incorporating high strength, UV stable, thermoplastic material. Contact Customer Service for testing data.

POLYCARBONATE RAIL BRACKET KITS



| | Product No. | Description | Box Wt. | Box Qty. |
|--|------------------|--|---------|----------|
| | #1321 | T-Rail Bracket Kit <i>The T-Rail Kit includes:</i> (1) T-Rail Bracket, (1) 2" x 3-1/2" Rail Bracket, (10) #10 x 1-1/4" Phillips Pan Head Screws, (12) Screw Hole Plugs, (4) Self-Drilling Phillips Pan Head Screws (self-drilling in order to drill into the aluminum stiffener), (4) PVC Screw Covers, (1) Instruction Sheet. | 13 lbs | 30 |
| | #1359 | 2" x 3-1/2" Rail Bracket Kit <i>The 2" x 3-1/2" Rail Kit includes:</i> (2) 2" x 3-1/2" Rail Brackets, (8) #10 x 1-1/4" Phillips Pan Head Screws, (8) Screw Hole Plugs, (4) Self-Drilling Phillips PanHead Screws (self-drilling in order to drill into the aluminum stiffener), (4) PVC Screw Covers, (1) Instruction Sheet. | 12 lbs | 30 |
| | #1357 | T-Rail Stair Bracket Kit <i>The T-Rail Stair Kit includes:</i> (1) T-Rail Stair Bracket, Top, (1) T-Rail Stair Bracket, Bottom, (12) #10 x 1-1/4" Phillips Pan Head Stainless Steel Screws, (12) Screw Hole Plugs, (2) Self-Drilling Phillips Pan Head Screws (self-drilling in order to drill into the aluminum stiffener), (2) PVC Screw Covers, (1) Instruction Sheet. | 16 lbs | 30 |
| | #1358 | 2" x 3-1/2" Stair Rail Bracket Kit <i>The 2" x 3-1/2" Stair Rail Kit includes:</i> (2) 2" x 3-1/2" Stair Rail Brackets, (8) #10 x 1-1/4" Phillips Pan Head Stainless Steel Screws, (8) Screw Hole Plugs, (2) Self-Drilling Phillips Pan Head Screws (self-drilling in order to drill into the aluminum stiffener), (2) PVC Screw Covers, (1) Instruction Sheet. | 14 lbs | 30 |
| | #1413 | 2" x 3-1/2" 45 Degree Bracket Kit <i>Includes: (2) 2"x3-1/2" Brackets / (12) Screw Hole Plugs / (12) #10x 1-1/4" Phillips Pan Head Screws.</i> | 7 lbs | 10 |
| | #1414 | T-RAIL 45 Degree Bracket Kit <i>Includes: (2) T-Rail Brackets / (12) Screw Hole Plugs / (12) #10x 1-1/4" Phillips Pan Head Screws</i> | 8 lbs | 10 |

TO ORDER: Call 888-570-5252 ext. 74, Fax: 609-989-1199, Email: orders@lmtproducts.com

HANDRAIL BRACKETS



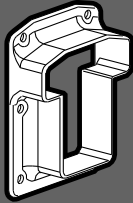
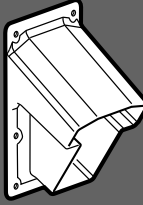
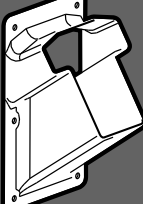
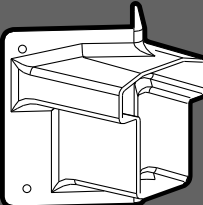
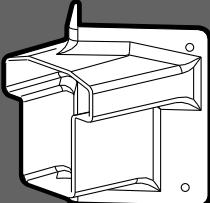
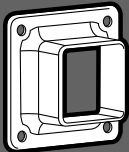
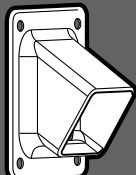

| | Product No. | Description | Box Wt. | Box Qty. |
|---|-------------|--|---------|----------|
|  | #1086 | T-Rail Straight Bracket <i>Bracket extends 1.250" over the profile.</i> | 15 lbs | 120 |
|  | #1087 | T-Rail Stair Top Bracket <i>Bracket designed for 7" rise and 11" run (32.5 angle). / Bracket extends 1.250" over the profile.</i> | 13 lbs | 60 |
|  | #1088 | T-Rail Stair Bottom Bracket <i>Bracket designed for 7" rise and 11" run (32.5 angle). / Bracket extends 1.250" over the profile.</i> | 13 lbs | 60 |
|  | #1089 | T-Rail 45° Left Bracket <i>Bracket designed for 45 angle. / Bracket extends 1.250" over the profile.</i> | 11 lbs | 50 |
|  | #1090 | T-Rail 45° Right Bracket <i>Bracket designed for 45 angle. / Bracket extends 1.250" over the profile.</i> | 11 lbs | 50 |
|  | #1294 | 1-3/4" x 1-3/4" Straight Bracket <i>Maximum profile dimensions: 1.760" x 1.760" / corner radius: .125" / Fits externally / Total height: 1.250 / Overall outside dimensions: 3.250" x 3.250".</i> | 8.6 lbs | 130 |
|  | #1295 | 1-3/4" x 1-3/4" Stair Bracket <i>Maximum profile dimensions: 1.760" x 1.760" / Corner radius: .125" / Fits externally / Total height: 1.930 / Overall outside dimensions: 3.250" x 4.000".</i> | 9.1 lbs | 100 |

TO ORDER: Call 888-570-5252 ext. 74, Fax: 609-989-1199, Email: orders@lmtproducts.com

HANDRAIL BRACKETS

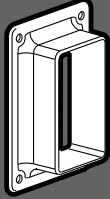

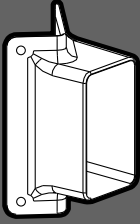
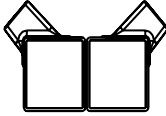
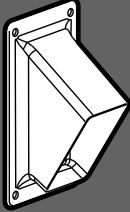
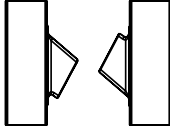
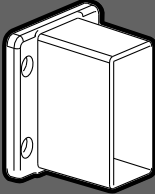
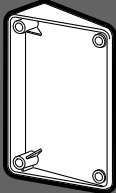
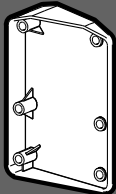

| | Product No. | Description | Box Wt. | Box Qty. |
|---|-------------|--|---------|----------|
|  | #1092 | <p>2" x 3-1/2" Straight Bracket</p> <p><i>Fits a profile measuring 2.000" X 3.500" / Corner radius: 0.188" / Extends 1.250" over the profile.</i></p>  | 14 lbs | 120 |
|  | #1093 | <p>2" x 3-1/2" 45° Bracket</p> <p><i>Fits a profile measuring 2.000" X 3.500" / Corner radius: 0.188" / Bracket designed for 45 angle. / Fits right & left / Bracket extends 1.250" over profile.</i></p>  | 11 lbs | 60 |
|  | #1094 | <p>2" x 3-1/2" Stair Bracket</p> <p><i>Fits a profile measuring 2.000" X 3.500" / Corner radius: 0.188" / Bracket designed for 7" rise and 11" run (32.5 angle). / Fits top & bottom / Bracket extends 1.250" over profile.</i></p>  | 12 lbs | 60 |
|  | #1081 | <p>2" x 3-1/2" Internal Bracket</p> <p><i>Minimum profile inside dimensions: 1.750" X 3.250" / Corner radius: 0.125" / Fits internally / Extends into profile: 2.625" / Overall outside dimension: 3.485" X .500" / Fits inside the extrusion.</i></p> | 26 lbs | 100 |
|  | #1053 | <p>2" x 3-1/2" Rail Wedge</p> <p><i>Designed for part number #1092 to be placed on a 22 1/2° angle / Uses screw #4026.</i></p> <p>Attention Gazebo Manufacturers: 22 1/2° bracket.</p> | 12 lbs | 60 |
|  | #1054 | <p>T-Rail Wedge</p> <p><i>Designed for part number #1086 to be placed on a 22 1/2° angle / Uses screw #4026.</i></p> <p>(Note: Does not match with T-Rail Bracket Kit #1182.)</p> <p>Attention Gazebo Manufacturers: 22 1/2° bracket.</p> | 13 lbs | 60 |

TO ORDER: Call 888-570-5252 ext. 74, Fax: 609-989-1199, Email: orders@lmtproducts.com

HANDRAIL BRACKETS

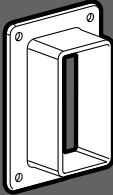

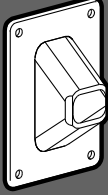
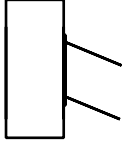
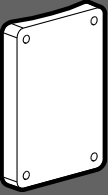
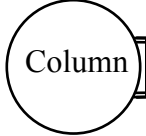
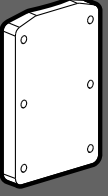
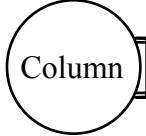

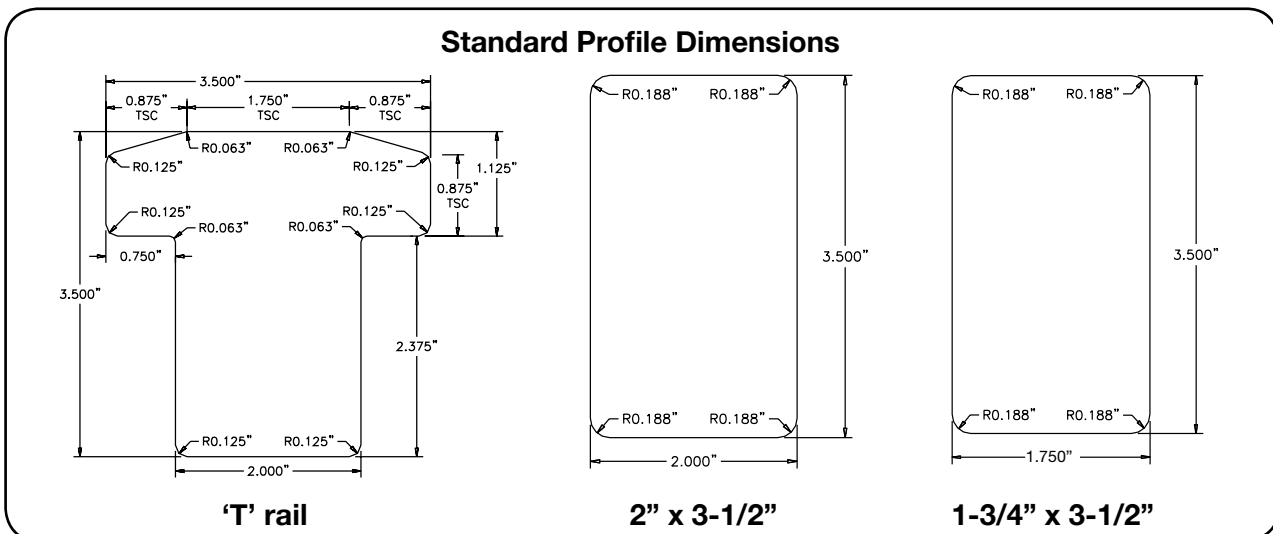
| | Product No. | Description | Box Wt. | Box Qty. |
|---|-------------|---|---------|----------|
|  | #1109 | <p>1-3/4" x 3-1/2" Straight Bracket</p> <p>Maximum profile dimensions: 1.755" X 3.510" / Corner radius: 0.075" / Fits externally / Total height 1.500" / Overall outside dimension: 3.450" X 4.960".</p>  | 11 lbs | 50 |
|  | #1108 | <p>1-3/4" x 3-1/2" Stair Bracket</p> <p>Bracket allows for 1 3/4" x 3 1/2" to be installed on stairs at various angles / Fits internally.</p>  | 15 lbs | 75 |
|  | #1111 | <p>2" x 3-1/2" Post Connector</p> <p>Designed to allow our 2" x 3 1/2" Straight Rail Bracket #1092 to be mounted to a 8" diameter posts / Uses screw #4025.</p>  | 15 lbs | 90 |
|  | #1112 | <p>T-Rail Post Connector</p> <p>Designed to allow our T-Rail Straight Bracket #1086 to be mounted to a 8" diameter posts / Uses screw #4025.</p> <p>Note: Does not match with #1182 Bracket Kit.</p>  | 15 lbs | 90 |



TO ORDER: Call 888-570-5252 ext. 74, Fax: 609-989-1199, Email: orders@lmtproducts.com

HANDRAIL BRACKETS

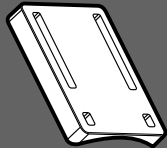
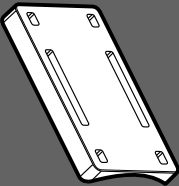
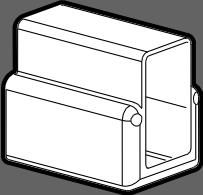
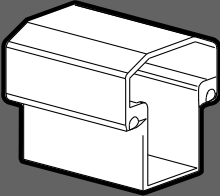
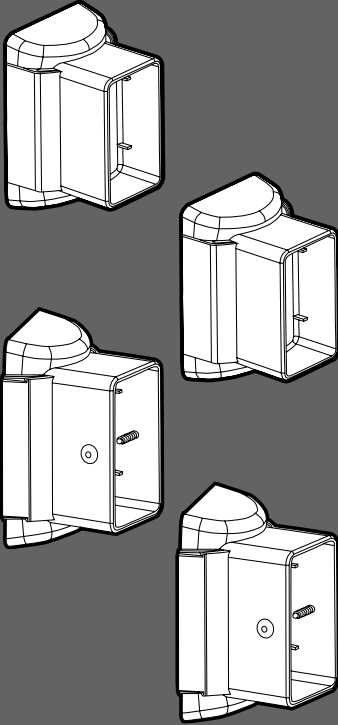

| | Product No. | Description | Box Wt. | Box Qty. |
|---|--|---|---------|----------|
|  | #1305A | 8" Column Adapter for Straight Bracket <i>Designed for attaching rail bracket #1182 and #1219 to a 8" column.</i> | 5 lbs | 26 |
|  | #1305B | 8" Column Adapter for Stair Bracket <i>Designed for attaching rail brackets #1276, #1277, #1087, #1088 to a 8" column.</i> | 5 lbs | 22 |
|  | #1184 | 2" x 3-1/2" Adjustable Bracket <i>Bracket is 4.926" long / May be cut at many angles for stair and corner applications.</i> | 17 lbs | 24 |
|  | #1185 | T-Rail Adjustable Bracket <i>Bracket is 4.225" long / May be cut at many angles for stair and corner applications.</i> | 15 lbs | 24 |
|  | #1407W  | Multi-Angle 2" x 3-1/2" Rail Kit with Hidden Screws <i>Kit includes (2) 2"x3-1/2" brackets with side rail screw holes / (2) 2"x 3-1/2" brackets with hidden screws / (12) #10 x 1-1/2" an head screws / (8) screw covers / (4) #10x1" flathead screws / (4) screw plugs / 6- 4 packs per box.</i> | 12 lbs | 6 |

TO ORDER: Call 888-570-5252 ext. 74, Fax: 609-989-1199, Email: orders@lmtproducts.com

HANDRAIL BRACKETS

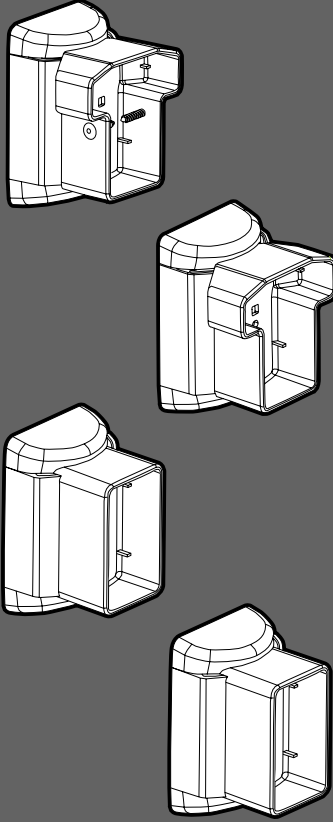
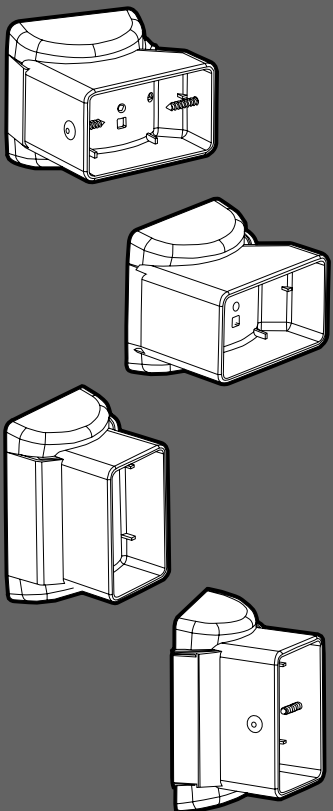
| | Product No. | Description | Box Wt. | Box Qty. |
|---|---|---|---------|----------|
|  | <p>#1405W</p> <p>NEW RELEASE</p> | <p>Multi-Angle "T Rail" Kit with Hidden Screws</p> <p><i>Kit includes (2) "T-Rail" brackets with side rail screw holes / (2) 2"x 3-1/2" brackets with hidden screws / (12) #10 x 1-1/2" an head screws / (8) screw covers / (4) #10x1" flathead screws / (4) screw plugs / 6- 4 packs per box.</i></p> | 12 lbs | 6 |
|  | <p>#1406W</p> <p>NEW RELEASE</p> | <p>Multi-Angle Horizontal 3-1/2"x 2" Rail Kit</p> <p><i>Kit includes (2) 3-1/2"x 2" brackets with side rail screw holes / (2) 2"x 3-1/2" brackets with hidden screws / (12) #10 x 1-1/2" an head screws / (8) screw covers / (4) #10x1" flathead screws / (4) screw plugs / 6- 4 packs per box.</i></p> | 12 lbs | 6 |

TO ORDER: Call 888-570-5252 ext. 74, Fax: 609-989-1199, Email: orders@lmtproducts.com

HANDRAIL BRACKETS

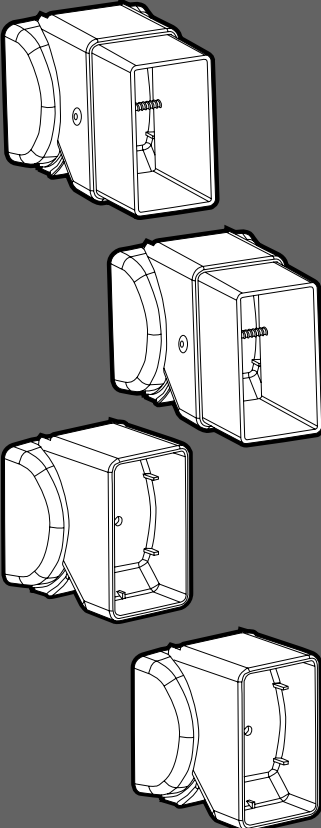
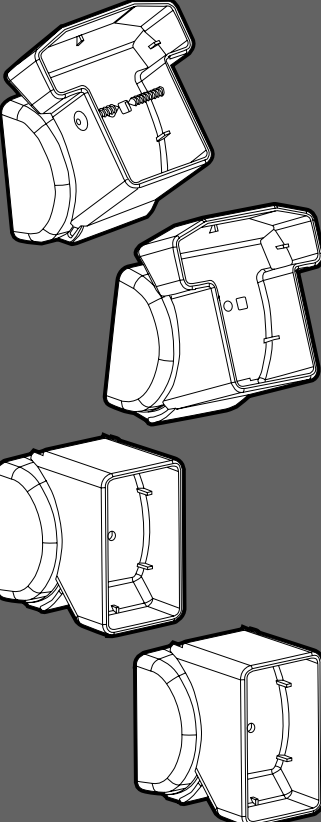
| | Product No. | Description | Box Wt. | Box Qty. |
|---|---|--|---------|----------|
|  | <p>#1403W</p> <p>NEW RELEASE</p> | <p>Multi-Angle 2"x 3-1/2" Stair Kit</p> <p><i>Kit includes (2) 2"X 3-1/2" stair brackets with side rail screw holes / (2) 2"x 3-1/2" stair brackets with hidden screws / (12) #10 x 1-1/2" an head screws / (8) screw covers / (4) #10x1" flathead screws / (4) screw plugs / 6- 4 packs per box.</i></p> | 12 lbs | 6 |
|  | <p>#1402W</p> <p>NEW RELEASE</p> | <p>Multi-Angle "T-Rail" Stair Kit</p> <p><i>Kit includes (2) "T-Rail" stair brackets with side rail screw holes * 1-Up & 1- Down / (2) 2"x 3-1/2" stair brackets with hidden screws / (12) #10 x 1-1/2" an head screws / (8) screw covers / (4) #10x1" flathead screws / (4) screw plugs / 6- 4 packs per box.</i></p> | 12 lbs | 6 |

TO ORDER: Call 888-570-5252 ext. 74, Fax: 609-989-1199, Email: orders@lmtproducts.com



POST SKIRTS

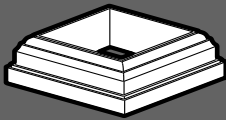
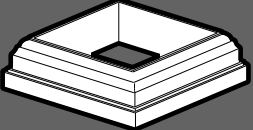
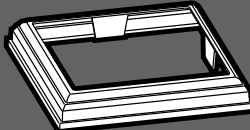
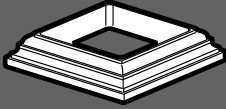
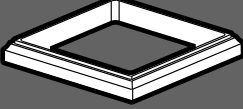
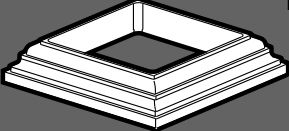

| | Product No. | Description | Box Wt. | Box Qty. |
|---|-------------|---|---------|----------|
|  1.660" | #1069-A | 4" New England Post Skirt <i>Maximum profile dimensions: 4.030" X 4.030" / Corner radius: 0.125 / Fits externally / Total height 1.663" / Overall outside dimension: 5.920".</i> | 14 lbs | 32 |
| | #1069-B | 4" New England Post Skirt <i>Maximum profile dimensions: 4.030" X 4.030" / Corner radius: 0.281 / Fits externally / Total height 1.663" / Overall outside dimension: 5.920".</i> | 14 lbs | 32 |
| | #1069-C | 4" New England Post Skirt <i>Maximum profile dimensions: 4.030" X 4.030" / Corner radius: 0.375 / Fits externally / Total height 1.663" / Overall outside dimension: 5.920".</i> | 14 lbs | 32 |
|  2.078" | #1070-A | 5" New England Post Skirt <i>Maximum profile dimensions: 5.030" X 5.030" / Corner radius: 0.125 / Fits externally / Total height 2.078" / Overall outside dimension: 6.920".</i> | 28 lbs | 60 |
| | #1070-B | 5" New England Post Skirt <i>Maximum profile dimensions: 5.030" X 5.030" / Corner radius: 0.800 / Fits externally / Total height 2.078" / Overall outside dimension: 6.920".</i> | 28 lbs | 60 |
|  | #1301 | 6" New England Post Skirt <i>Maximum profile dimensions: 6.010" X 6.010" / Corner radius: 0.180" / Fits externally / Total height 1.296" / Overall outside dimension: 8.068".</i> | 18 lbs | 56 |
| | #1303 | 6-1/2" New England Post Skirt <i>Maximum profile dimensions: 6.510" X 6.510" / Corner radius: 0.800" / Fits externally / Total height 2.078" / Overall outside dimension: 8.068".</i> | 17 lbs | 56 |
|  1.000" | #1104 | 4" Low Profile <i>Maximum profile dimensions: 4.010" X 4.010" / Corner radius: 0.188" / Fits externally / Total height 1.000" / Overall outside dimension: .650".</i> | 7 lbs | 32 |
|  0.650" | #1105 | 5" Low Profile <i>Maximum profile dimensions: 5.020" X 5.020" / Corner radius: 0.156" / Fits externally / Total height 0.650" / Overall outside dimension: 5.675".</i> | 6 lbs | 56 |
|  1.025" | #1227 | 6" Low Profile <i>Maximum profile dimensions: 6.020" X 6.020" / Corner radius: 0.156" / Fits externally / Total height 1.025" / Overall outside dimension: 7.665".</i> | 10 lbs | 30 |
| | #1228 | 6-1/2" Low Profile <i>Maximum profile dimensions: 6.520" X 6.520" / Corner radius: 0.188" / Fits externally / Total height 1.025" / Overall outside dimension: 8.165".</i> | 10 lbs | 30 |

TO ORDER: Call 888-570-5252 ext. 74, Fax: 609-989-1199, Email: orders@lmtproducts.com

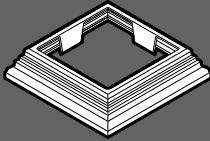
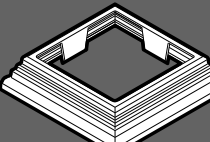
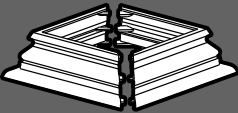
POST SKIRTS

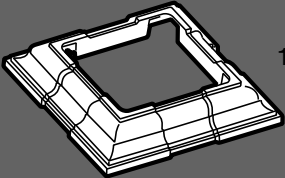
| | Product No. | Description | Box Wt. | Box Qty. |
|---|--------------|--|---------|----------|
|  <p>1.425"</p> | #1232 | 4" Nantucket Post Skirt <i>Maximum profile dimensions: 4.020" X 4.020" / Corner radius: 0.188" / Fits externally / Total height 1.425" / Overall outside dimension: 5.780".</i> | 8 lbs | 32 |
|  <p>2.425"</p> | #1235 | 5" Nantucket Post Skirt <i>Maximum profile dimensions: 5.020" X 5.020" / Corner radius: 0.188" / Fits externally / Total height 2.425" / Overall outside dimension: 6.780".</i> | 20 lbs | 75 |
|  <p>2.460"</p> | #1137 | 4" Federation Two-Piece Post Skirt <i>Maximum profile dimensions: 4.030" X 4.030" / Corner radius: 0.125" / Fits externally / Total height 2.460" / Overall outside dimension: 5.630".</i> | 41 lbs | 88 |
| | #1138 | 5" Federation Two-Piece Post Skirt <i>Maximum profile dimensions: 5.020" X 5.020" / Corner radius: 0.125" / Fits externally / Total height 2.460" / Overall outside dimension: 6.630".</i> | 52 lbs | 96 |
| | #1224 | 6" Federation Two-Piece Post Skirt <i>Maximum profile dimensions: 6.020" X 6.020" / Corner radius: 0.156" / Fits externally / Total height 2.460" / Overall outside dimension: 6.630".</i> | 24 lbs | 24 |
| | #1212 | 6-1/2" Federation Two-Piece Post Skirt <i>Maximum profile dimensions: 6.520" X 6.520" / Corner radius: 0.135" / Fits externally / Total height 2.460" / Overall outside dimension: 9.312".</i> | 24 lbs | 24 |
|  <p>1.000"</p> | #1156 | 4" Two-Piece Post Skirt <i>Maximum profile dimensions: 4.030" X 4.030" / Corner radius: 0.156" / Fits externally / Total height 1.000" / Overall outside dimension: 5.630".</i> | 8 lbs | 50 |
| | #1157 | 5" Two-Piece Post Skirt <i>Maximum profile dimensions: 5.020" X 5.020" / Corner radius: 0.156" / Fits externally / Total height 1.000" / Overall outside dimension: 6.630".</i> | 9 lbs | 50 |
|  <p>1.226"</p> | #1189 | Four-Piece Post Trim <i>Designed to fit 6-1/2", 5" & 4" posts. Adjustable OD / Corner radius: 0.256" / Fits externally / Total height 1.226" / Available in White and LMT Almond.</i> | 28 lbs | 75 Sets |

TO ORDER: Call 888-570-5252 ext. 74, Fax: 609-989-1199, Email: orders@lmtproducts.com

POST ACCENTS

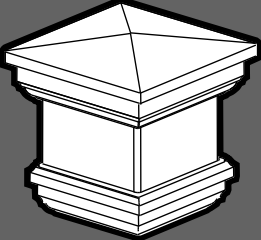
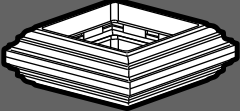
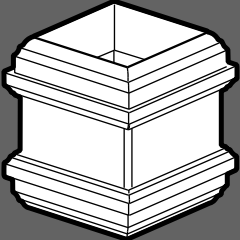
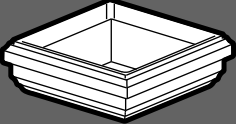
| | Product No. | Description | Box Wt. | Box Qty. |
|---|-------------|---|---------|----------|
|  | #1095 | 4" Newport Post Cap <i>Maximum profile dimensions: 4.010" x 4.010" / Corner radius: Square / Fits externally / Extends 1.250" over the profile / Total height 6.125" / Available in White.</i> | 25 lbs | 12 |
|  | #1096 | 4" Decorative Knuckle <i>Maximum profile dimensions: 4.010" x 4.010" / Corner radius: Square / Fits externally / Total height 2.800" / Colors available.</i> | 10 lbs | 24 |
| | #1098 | 5" Decorative Knuckle <i>Maximum profile dimensions: 5.010" x 5.010" / Corner radius: Square / Fits externally / Total height 3.470" / Colors available.</i> | 20 lbs | 18 |
|  | #1097 | 4" Decorative Knuckle With Spacer <i>Maximum profile dimensions: 4.010" x 4.010" / Corner radius: Square / Fits externally / Total height 5.175" / Available in White.</i> | 13 lbs | 8 |
|  | #1100 | 4" to 5" Decorative Transition <i>Maximum profile dimensions: 4.010" x 4.010" to 5.010" x 5.010" / Corner radius: Square / Fits externally / Total height 1.650" / Colors available.</i> | 11 lbs | 16 |

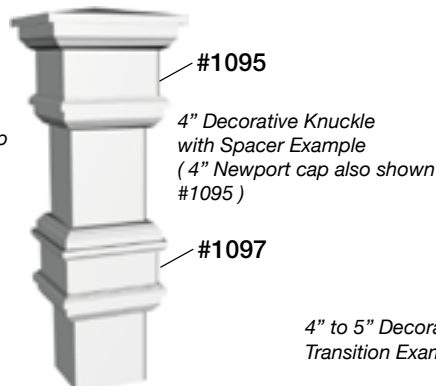
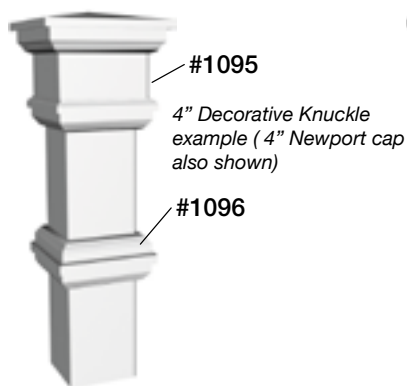

4" to 5" Decorative Transition Example

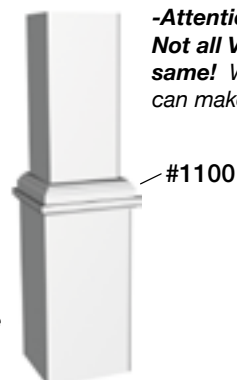



-Attention Fabricators-
Not all Vinyl Posts have to look the same! With our Post Accents, you can make designs like these.

TO ORDER: Call 888-570-5252 ext. 74, Fax: 609-989-1199, Email: orders@lmtproducts.com

RAIL MOUNTS

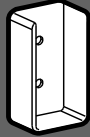
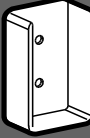
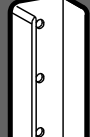
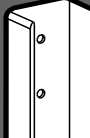

| | Product No. | Description | Box Wt. | Box Qty. |
|---|-----------------------------|--|---------|----------|
|  | #1153 | 1-3/4" x 3-1/2" <i>Maximum profile dimensions: 1.755" wide / Corner radius: 0.15625" / Fits externally / Extends 1.160" over the profile.</i> | 16 lbs | 150 |
|  | #1150 | 2" x 3-1/2" <i>Maximum profile dimensions: 2.010" wide / Corner radius: 0.15625" / Fits externally / Extends 1.160" over the profile.</i> | 12 lbs | 100 |
|  | #1154 | 1-1/2" x 5-1/2" <i>Maximum profile dimensions: 1.510" wide / Corner radius: 0.15625" / Fits externally / Extends 1.160" over the profile.</i> | 16 lbs | 100 |
|  | #1151 | 2" x 6" <i>Maximum profile dimensions: 2.010" wide / Corner radius: 0.15625" / Fits externally / Extends 1.160" over the profile.</i> | 18 lbs | 100 |
|  | #1372 NEW RELEASE | 2" x 7" Rail Mount <i>Maximum profile dimensions: 2.010" / Corner radius: 0.156" / Fits externally / Extends 1.160" over the profile.</i> | 21 lbs | 100 |
|  | #1373 NEW RELEASE | 2" x 8" Rail Mount <i>Maximum profile dimensions: 2.010" / Corner radius: 0.156" / Fits externally / Extends 1.160" over the profile.</i> Designed not to snag on the screw heads when installing the rails. | 19 lbs | 80 |

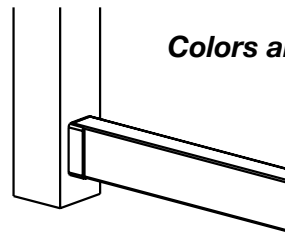
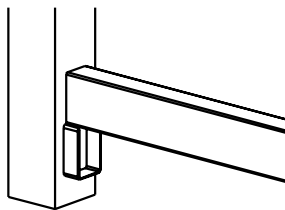
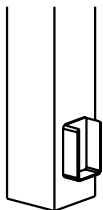

Colors are available. See page 3.

TO ORDER: Call 888-570-5252 ext. 74, Fax: 609-989-1199, Email: orders@lmtproducts.com



ADA Compliant Hand Rail System

LMT Mercer Group, Inc.

Mounts to vinyl, wood, or metal railing systems to provide code compliant installations wherever needed.



▲ 1-1/2" OD aluminum reinforced vinyl is ADA compliant. Patented adjustable internal joiner eliminates fittings and accommodates any angle.

▲ Create continuous code handrail on any stair or ramp. Simple to install on site.

- 1-1/2" OD vinyl meets the "Americans with Disabilities Act" graspability requirements.
- Unique adjustable internal joiner accommodates any transition, stair, or ramp angle.
- Easily installs on site with no preformed fittings.
- Heavy wall vinyl exterior and over-engineered aluminum interior provide maintenance free strength and durability.
- Can be installed in any stair or ramp configuration; continuously or interrupted.
- Mounts to wood, vinyl, or metal railing systems to provide code compliant graspability.
- Installs like wood - no special tools required.
- Eliminates ugly pre-bent fittings.

With stairs & ramps, it's all about angles. Our adjustable internal joiner is infinitely adjustable to fit any stair, ramp, or transition angle. This Spaghetti Rail System has a 12 year history as the nation's most innovative, code compliant, vinyl railing system available. This experience brings another industry first with our adjustable internal joint (patent pending). Simply cut the rail to the desired angle using a mitre saw; adjust the joiner to the proper angle; then glue in place. Accommodates angles from 0° - 90°. Pre-bent fittings with other systems just don't work. No two stairs or ramps are alike. Fittings preformed to a few selected angles make it impossible to accommodate every situation. With the Spaghetti Rail continuous vinyl handrail system, code compliance is simple!

IT'S ALL ABOUT ANGLES

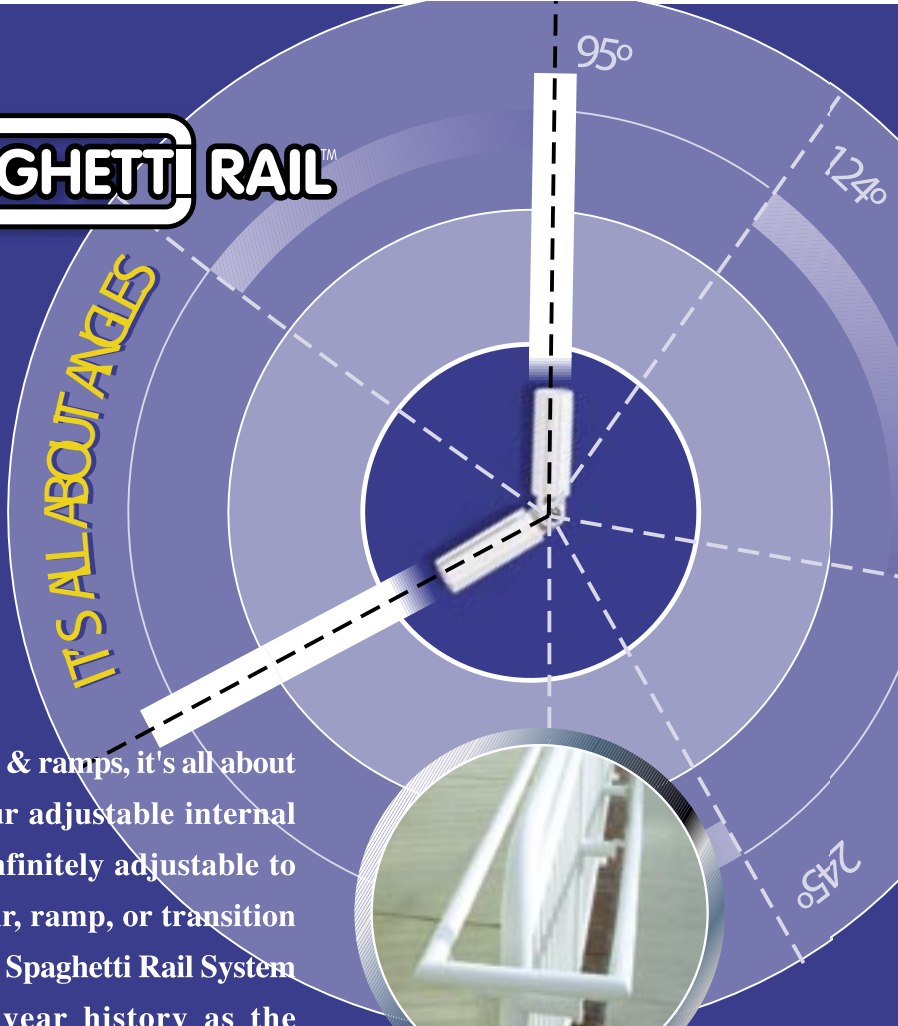

Wall mounted handrail can be fabricated on site using a mitre saw and our adjustable joiner to create a continuous configuration. Shown are two rail sections mitred to fit, including two internal joiners. They allow the rail to follow any wall and ramp configuration.



ADA compliant ramp rail is simple with Spaghetti Rail. End loops, rail extensions, returns, and transitions are all easily installed on site. Spaghetti Rail's continuous vinyl handrail can be mounted to any railing material, vinyl, wood, or steel.

SYSTEM COMPONENTS

INSERTS

#5219 - Adjustable internal joiner. Use with vinyl adhesive.



#5217 - 30" flange post interior - galvanized. Use with #5216 end post & #5221 flange cover. Mounts to wood or concrete surfaces using lag screws or concrete anchors. *(Note: Not designed to be self supporting, should attach to guard rail system)*



#5218 - 34" core post interior - galvanized. Use with #5216 end post for core mount applications in masonry surfaces.



1-1/2"OD VINYL TUBING

#5228 - 1-1/2" OD - ADA post return 16 1/2" x 6"

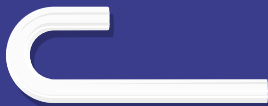

1-1/2"OD VINYL TUBING

#5210 - 1-1/2" OD x 6 vinyl hand rail with aluminum insert.
#5211 - 1-1/2" OD x 8 vinyl hand rail with aluminum insert.
#5212 - 1-1/2" OD x 10 vinyl hand rail with aluminum insert.
(Vinyl and aluminum also sold separately, see back page)



#5214 - 1-1/2" OD - 90° wall return - 12" x 12 3/4"
(For longer returns to wall surface use 5215 and cut to fit on site)



#5215 - 1-1/2" OD - 90° corner
(Can be trimmed on site to create 90° wall returns)



#5216 - 1-1/2" OD - 90° corner/end post - 12" x 36". Can be installed as a long corner to reduce joints or used with galvanized post interiors #5217 or #5218 to create a return to grade end post.



#5213 - 1-1/2" OD ADA end loop 18" x 12" x 18"



CAPS & COVERS

#5220 - 1-1/2" DIA vinyl end cap. Install with vinyl adhesive.



#5221 - Flange cover 3 1/2" x 3 1/2". Use to cover #5225 mini wall flange or #5217 flange post.



MOUNTING BRACKETS

#5222 - White powder coated handrail bracket kit - set of 2 with stainless steel mounting screws.



#5225 - 2 1/2" mini wall mount flange - aluminum. Use to terminate straight rail at wall surface. Use with #5221 flange cover. Not to be used with #5214 - 90° wall return. *(See diagram)*





ORDERING GUIDE

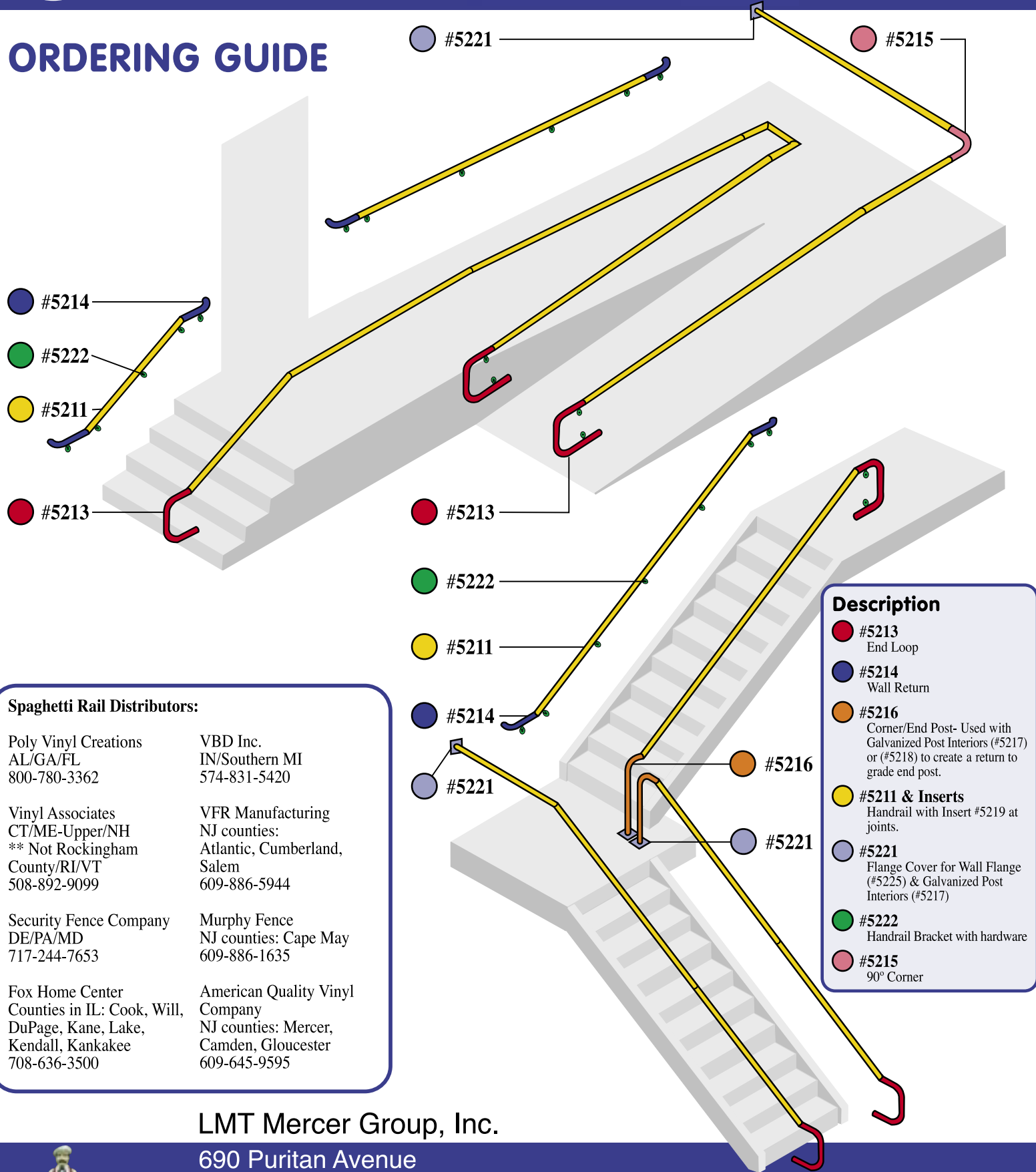

● #5214

● #5222

● #5211

● #5213

● #5221

● #5215

● #5213

● #5222

● #5211

● #5214

● #5221

● #5216

● #5221

Description

- #5213
End Loop
- #5214
Wall Return
- #5216
Corner/End Post- Used with Galvanized Post Interiors (#5217) or (#5218) to create a return to grade end post.
- #5211 & Inserts
Handrail with Insert #5219 at joints.
- #5221
Flange Cover for Wall Flange (#5225) & Galvanized Post Interiors (#5217)
- #5222
Handrail Bracket with hardware
- #5215
90° Corner

Spaghetti Rail Distributors:

Poly Vinyl Creations
AL/GA/FL
800-780-3362

VBD Inc.
IN/Southern MI
574-831-5420

Vinyl Associates
CT/ME-Upper/NH
** Not Rockingham
County/RI/VT
508-892-9099

VFR Manufacturing
NJ counties:
Atlantic, Cumberland,
Salem
609-886-5944

Security Fence Company
DE/PA/MD
717-244-7653

Murphy Fence
NJ counties: Cape May
609-886-1635

Fox Home Center
Counties in IL: Cook, Will,
DuPage, Kane, Lake,
Kendall, Kankakee
708-636-3500

American Quality Vinyl
Company
NJ counties: Mercer,
Camden, Gloucester
609-645-9595

LMT Mercer Group, Inc.

690 Puritan Avenue
Lawrenceville, NJ 08648
Ph: (888) 570-5252
Fax: (609) 989-0969



LIGHTING

Each year, LMT Mercer Group, Inc. adds more lighting options from which customers can choose. Lighting is one way customers can add a unique touch to their decks or railing. We construct our lighting products with only high-grade, commercial components.

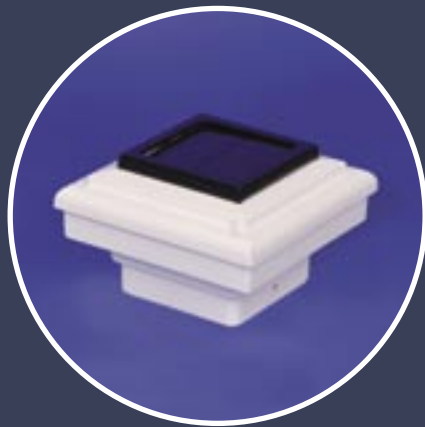
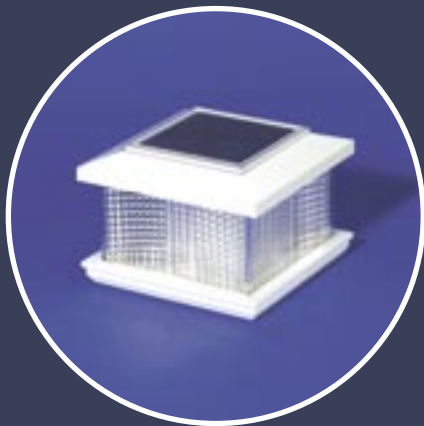

 LMT Mercer Group, Inc.